



INSTRUCTIONS 1006-C00 e

Section	1006
Effective	March 2018
Replaces	March 2017

Original instructions

CENTREX MULTI 2

Version 3



INSTALLATION

OPERATION

MAINTENANCE



2M version (Meter)



2ME version (Electronic Meter)



2T version (Turbine)

WARRANTY :

CENTREX MULTI 2 units are covered 24 months by warranty within the limits mentioned in our General Sales Conditions. In case of a use other than that mentioned in the Instructions manual, and without preliminary agreement of MOUVEX, warranty will be canceled.



Z.I. La Plaine des Isles - F 89000 AUXERRE - FRANCE
Tel. : +33 (0)3.86.49.86.30 - Fax : +33 (0)3.86.49.87.17
contact@mouvex.com - www.mouvex.com

Your distributor :

MEASURED UNLOADING UNIT MOUVEX

SAFETY, STORAGE, INSTALLATION AND MAINTENANCE INSTRUCTIONS

MODEL : CENTREX MULTI 2

Definition of safety symbols



This is a SAFETY ALERT SYMBOL.

When you see this symbol on the product, or in the manual, look for one of the following signal words and be alert to the potential for personal injury, death or major property damage.



Warns of hazards that **WILL** cause serious personal injury, death or major property damage.



Warns of hazards that **CAN** cause serious personal injury, death or major property damage.

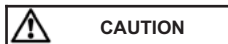

Warns of hazards that **CAN** cause personal injury or property damage.

NOTICE

Indicates special instructions which are very important and must be followed.

REMARKS :

MOUVEX CENTREX MULTI 2 units **MUST** be installed in systems designed by qualified personnel. The installation **MUST** be in compliance with local standards, national regulations and rules of safety.

This manual is designed to permit installation and commissioning of MOUVEX CENTREX MULTI 2 units and MUST accompany the compressor.

Maintenance of MOUVEX CENTREX MULTI 2 units must ONLY be carried out by qualified technicians. This maintenance must meet local and national standards as well as all safety regulations. Read this manual, including all instructions and warnings, in full BEFORE any use of MOUVEX CENTREX MULTI 2 units.

Do not remove the warning and use label stickers that are found on the compressors.

TABLE OF CONTENTS

Page



1. OVERALL DIMENSIONS	4
2. GENERAL DATA	5
2.1 Principle of operation5
2.2 Operating characteristics6
2.3 Operation6
3. INSTALLATION	7
3.1 No return valve item 15 calibration7
3.2 Pipe diameter7
3.3 Piping assembly7
3.4 Degassing7
3.5 Direction of rotation7
3.6 Alignment of motor/pump and reduction gearbox/pump shafts8
3.7 Electric motors8
3.8 Sealing of the unit9
4. STORAGE CONDITIONS	9
5. PRODUCTS UNLOADED	9
5.1 Class of products and installation zone9
5.2 Compatible products9
6. MAINTENANCE	10
6.1 Pump10
6.2 Filters10
7. SCRAPPING	10
8. CERTIFICATE OF CONFORMITY	11



ADDITIONAL DOCUMENTATION



The table below gives the list of instructions in addition to this central instruction :



	Application Instructions	Spare parts list
PF80 CC8 filter	NT 1011-G00	-
CC8-65 pump	NT 1010-D00	-
Meter SBM150	NT MA/027/00	MA/026/027/038
Motor	Supplier NT	-
Seal chassis	NT 1011-M00	-
CENTREX MULTI 2 unit	-	PL 1006-C01
CC8-65 ATEX pump	NT 1063	-



SAFETY DATA



 WARNING	<p>OPERATION WITHOUT THE SHAFT PROTECTOR CAN CAUSE SERIOUS PERSONAL INJURY, MAJOR PROPERTY DAMAGE OR DEATH.</p>
	
<p>Do not operate without guard in place.</p>	

 WARNING	<p>BEFORE STARTING, ENSURE THAT THE SAFETY FITTINGS (COVER, FAN HOOD, COUPLING CASING, ETC...) ARE IN PLACE AND FIXED.</p>
	
<p>Do not operate without guard in place.</p>	

 WARNING	<p>PUMPS OPERATING AGAINST A CLOSED VALVE CAN CAUSE SYSTEM FAILURE, PERSONAL INJURY AND PROPERTY DAMAGE.</p>
	
<p>Hazardous pressure can cause personal injury or property damage.</p>	

 CAUTION	<p>THE NOISE GENERATED BY THE CENTREX MULTI 2 UNIT CAN REACH 80 DB AT A DISTANCE OF 1 M. IT IS NECESSARY TO WEAR SOUND MUFFLERS IN THE VICINITY OF THE MACHINE.</p>
	
<p>A loud noise can cause permanent body damage.</p>	

 WARNING	<p>DISCONNECTING THE FLUID OR PRESSURE CONTAINMENT COMPONENTS DURING PUMP OPERATION CAN CAUSE SERIOUS PERSONAL INJURY, DEATH OR MAJOR PROPERTY DAMAGE.</p>
	
<p>Hazardous pressure can cause personal injury or property damage.</p>	

 WARNING	<p>INCORRECT SETTINGS OF THE PRESSURE RELIEF VALVE CAN CAUSE PUMP COMPONENT FAILURE, PERSONAL INJURY AND PROPERTY DAMAGE.</p>
	
<p>Hazardous pressure can cause personal injury or property damage.</p>	

SAFETY CHECK LIST

1. Seal chassis to the floor as recommended in the attached notice.
2. Check the alignment of motor and pump shafts after sealing of the chassis.
3. Connect the electric cable to the motor as shown in the instructions found in the terminal box.
4. Check the direction of rotation: direction indicated on the motor hood.
5. Connect the pipe(s) (depending on version) to the corresponding tanks.
6. The storage tank should have more free space available than the volume to be unloaded.
7. The product to be unloaded is compatible with the CENTREX MULTI 2 unit.
8. The CENTREX MULTI 2 unit is compatible with the zone in which it is installed and with the hazard class of the product.
9. Tanks to be unloaded must be equipped with a bleeder valve on every compartment in order to avoid any potential damage linked to a depression during the unloading.

HOISTING :

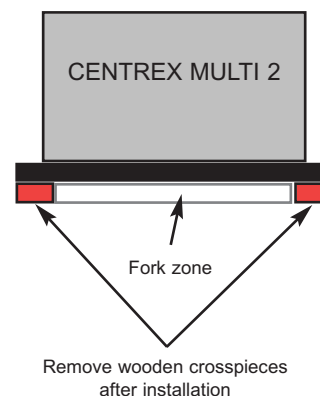

1. OVERALL DIMENSIONS

CENTREX MULTI 2 M

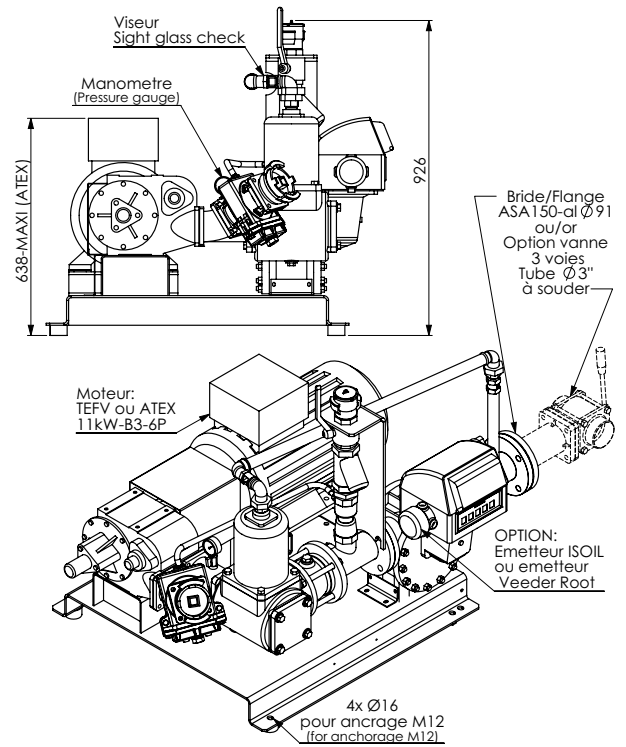
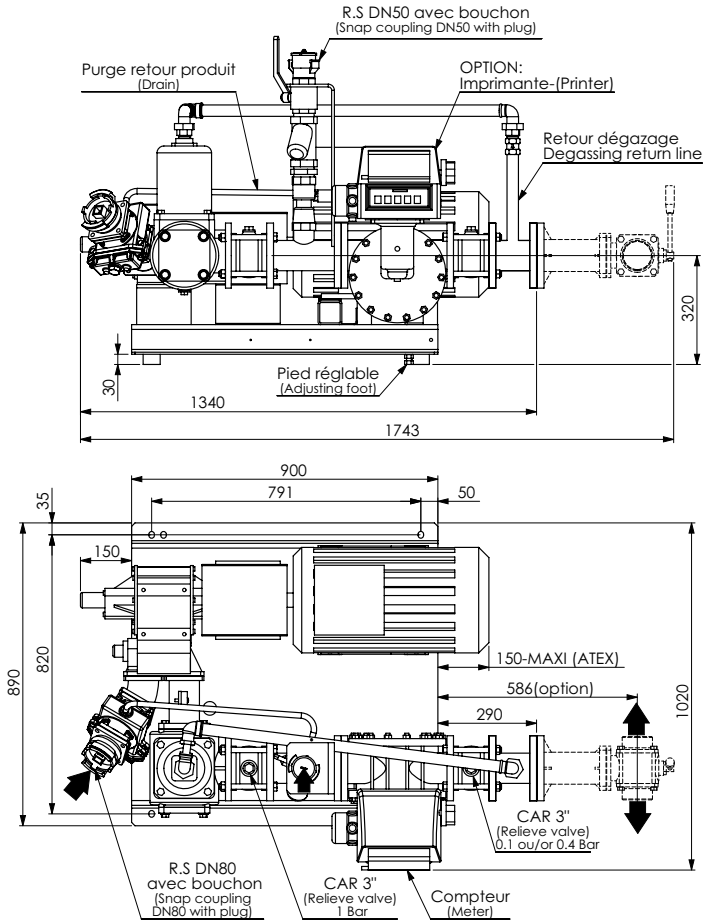

Weight : 400 kg

CENTREX MULTI 2 T

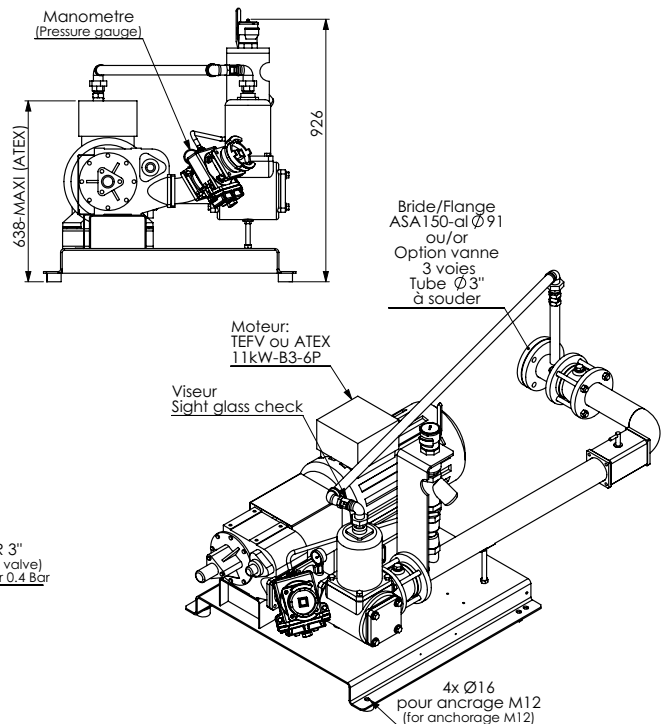
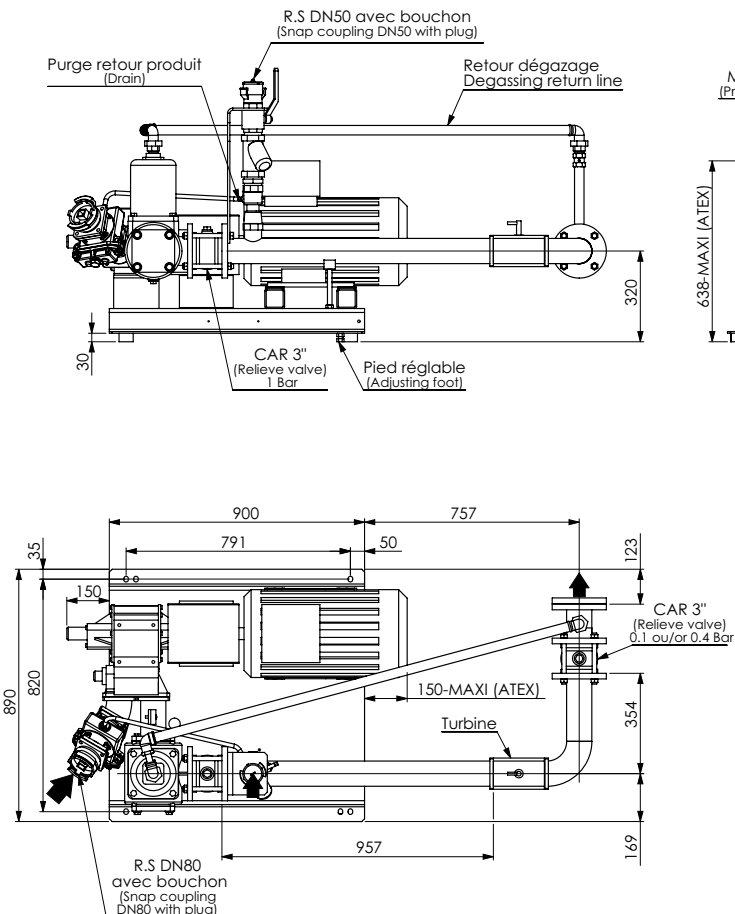



Weight : 390 kg

2. GENERAL DATA

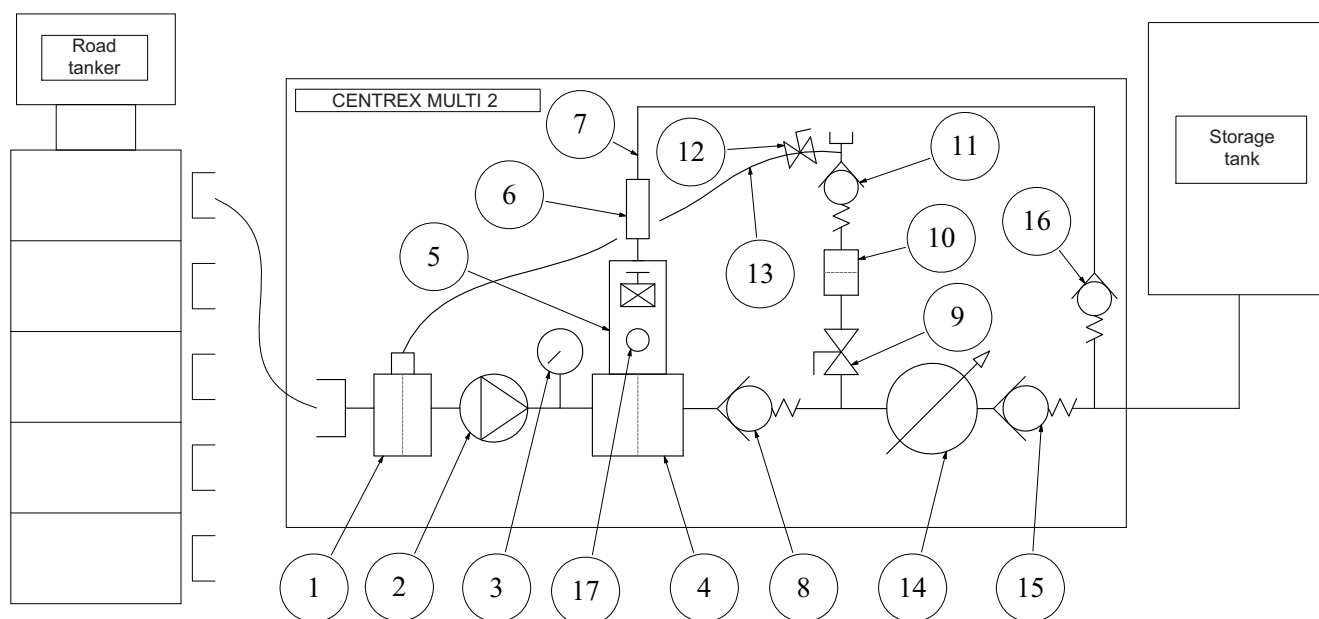
2.1 Principle of operation



 WARNING		OPERATION WITHOUT THE SHAFT PROTECTOR CAN CAUSE SERIOUS PERSONAL INJURY, MAJOR PROPERTY DAMAGE OR DEATH.
Do not operate without guard in place.		

1	Pump filter
2	CC8-65 pump
3	Pressure gauge
4	Meter filter
5	Gas separator
6	Sight glass
7	Degassing line
8	Check valve setted 1 bar
9	Valve
10	Product recapture filter
11	Check valve
12	Valve
13	Drainage pipe
14	Meter
15	Check valve setted 0,1 bar or 0,4 bar
16	Check valve

2.1.1 Unloading :

- Ground the vehicle.
- Connect the Centrex multi 2 unit to the compartment to be emptied via a DN80 hose. Then open the valve.
- Select the storage tank to be filled.
- If necessary, reset the meter to 0 and put a ticket in the printer.
- Starting-up of the pump.
- The product passes through the pump filter 1.
- The filter 4 allows to protect the meter.
- The gas separator 5 allows the air produced to be evacuated in case of stock shortages.
- The sight glass 6 allows checking that the gas separator works properly (no continuous flow of liquid).
- The degassing line 7 carries out the gas caught by the gas separator and move them after the meter in the discharge line.
- The no return valve 16 avoids any liquid return from going back to the gas separator.
- The setted valve 8 allows the degassing of the product and prevents its return to the pumping zone.
- The degassed product passes into the meter 14 with data recorded on the ticket or via electrical signals depending on the version.
- Once the compartment is empty, the assembly will fill with air and the meter will stop.

- If the next compartment contains the same product, connect the DN80 hose to it without stopping the pump.
- If the next compartment contains another product :
 - Lift the DN80 hose to drain it and wait for the meter to stop and the gas separator sight glass 17 to empty.
 - Print the ticket where necessary and reset the meter to zero.
 - Select the new storage tank to be filled.
 - Put a new ticket in the printer.
 - Connect the DN80 hose to the new compartment.
- Proceed in the same manner for the other compartments, lifting and draining the DN80 hose before stopping the pump.
- Refit the DN80 plug on filter 1.

2. GENERAL DATA (continued)



2.1.2 Product return :



- Ground the vehicle.
- Fit a DN50 connector to the nozzle and fix it to the product return device.
- Select the storage tank to be filled.
- If necessary, reset the meter to 0 and put a ticket in the printer.
- Do not turn on the CENTREX MULTI 2 unit pump to carry out this operation.
- Start measured distribution from the tanker and select the compartment to be emptied.
- Open the valve **9**.
- The liquid passes the no return valve **11**, crosses the strainer **10** and the meter **14**.
- The setted check valve **8** prevents any backflow.
- When the operation is finished :
 - Stop the measured distribution from the tanker.
 - Open the drainage valve **12** in order to return the residual volume to the pump, closing it again afterwards.
 - Disconnect the nozzle and reattach the DN50 plug.
 - The no return valve **15** generates an extra counter pressure requested when the storage tank is underground. That avoids generating a suction effect when the nozzle is disconnected in order to not suck any air.
 - Close the valve **9**.
 - Print the ticket where necessary and reset the counter to zero.



2.2 Operating characteristics

- Nominal flowrate60 m³/h
- Maximal differential pressure4 bar
- Maximum vacuum allowed-0,3 bar
- Running temperature-10° to +50°C
- The noise generated by the CENTREX unit under normal operating conditions . .80 dBA
- Minimum delivery500 litres
- Accuracy of the metering unit0,4 %
- Repeatability0,05 %

2.3 Operation

	WARNING	PUMPS OPERATING AGAINST A CLOSED VALVE CAN CAUSE SYSTEM FAILURE, PERSONAL INJURY AND PROPERTY DAMAGE.
		
Hazardous pressure can cause personal injury or property damage.		

	WARNING	DISCONNECTING THE FLUID OR PRESSURE CONTAINMENT COMPONENTS DURING PUMP OPERATION CAN CAUSE SERIOUS PERSONAL INJURY, DEATH OR MAJOR PROPERTY DAMAGE.
		
Hazardous pressure can cause personal injury or property damage.		



	WARNING	BEFORE STARTING, ENSURE THAT THE SAFETY FITTINGS (COVER, FAN HOOD, COUPLING CASING, ETC...) ARE IN PLACE AND FIXED.
		
Do not operate without guard in place.		



The operator should remain nearby the equipment throughout the use to ensure the proper functioning of the system.

The pump should not turn for more than two minutes if not fed with product or if a valve is closed to the outlet.

This unit is not approved for use in commercial transactions.

3. INSTALLATION

 WARNING	
	FAILURE TO RELIEVE THE SYSTEM PRESSURE PRIOR TO PERFORMING ANY WORK ON THE PUMP OR THE INSTALLATION CAN CAUSE PERSONAL INJURY OR PROPERTY DAMAGE.
Hazardous pressure can cause personal injury or property damage.	

 WARNING	
	SYSTEM FITTINGS AND HOSES MUST BE CAPABLE OF WITHSTANDING OPERATING PRESSURES.
Hazardous pressure can cause personal injury or property damage.	

3.1 No return valve item 15 calibration

The No return valve item 15 is available with 2 values of calibration to select when the order of the complete unit is placed :

- 0,1 bar calibration : storage in an above ground tank
- 0,4 bar calibration : storage in an under ground tank

3.2 Pipe diameter

It is important to take the following recommendations :

Head loss :

- The pipe diameter is chosen as a function of its length, the flow rate and the viscosity of the pumped product. However, it is never a disadvantage to over-dimension the inlet pipe diameters.
- Generally, the discharge pipe diameter(s) is a diameter equal to the ports of the pump.

Our Technical Services are always available to provide you with precise data if you give them accurate information or, better still, the installation plans.

3.3 Piping assembly

It is important to take the following recommendations :

- The location of the pump in the circuit should always be determined so as to reduce the height and length of the piping as much as possible particularly when used for suction.
- Wherever possible, siphons and reverse slopes should be avoided in the inlet piping.
- Particular care needs to be taken with the sealing on the inlet side to prevent air entering.
- Pipe elbows must always have a large radius (more than 3 times the diameter of the pipes) and must not be mounted too close to the pump flanges (min. recommended distance : 10 times the diameter of the pipes), on both the inlet and discharge sides.
- The pipes are supported and aligned with the pump in such a way as to avoid putting stress on the pump flanges. Non-compliance with this instruction can lead to deformation of pump parts, misalignment of bearings and accelerated material wear, even causing parts to break.



- The CENTREX MULTI, Turbine version, is delivered with the discharge piping module disconnected. That allows to reduce the dimensions and in consequence to minimize the packaging size. This module has to be connected (already tested in our workshop), please make sure the pipe is properly supported in order to avoid any vibrations creation as well tension on the unit.
- We recommend placing valves as close as possible to the pump ports to avoid having to drain the entire system each time maintenance is carried out. These valves should have the same diameter as the pipes and preferably by full bore models.
- Before installing new pipes or tanks, be sure to clean them very carefully to remove any solder, rust, etc. which could be carried along with the water and cause excessive pump wear.
- The pipes should be designed to allow for thermal expansion/contraction (the use of flexible hoses or expansion loops is recommended).
- If the liquid may freeze or solidify, prepare for draining the piping by installing drain taps at the low points and air vents at the high points.

3.4 Degassing

The gases caught by the gas separator are sent in the discharge line 7, downstream to the meter without disturbing the operation and the accuracy of the unit.

No connection is necessary.



3.5 Direction of rotation



 WARNING	
	OPERATION WITHOUT THE SHAFT PROTECTOR CAN CAUSE SERIOUS PERSONAL INJURY, MAJOR PROPERTY DAMAGE OR DEATH.
Do not operate without guard in place.	

The pump and unloading unit are not reversible. Ensure that the motor is connected correctly according to the pump's direction of rotation, indicated by arrows on the body.

3. INSTALLATION (continued)

3.6 Alignment of motor/pump and reduction gearbox/pump shafts

 WARNING	OPERATION WITHOUT THE SHAFT PROTECTOR CAN CAUSE SERIOUS PERSONAL INJURY, MAJOR PROPERTY DAMAGE OR DEATH.
	
Do not operate without guard in place.	

 WARNING	DISCONNECT THE ELECTRICITY SUPPLY BEFORE ANY MAINTENANCE OPERATION.
	
Dangerous voltage. Can cause injury and death.	

The motor and pump shafts are accurately aligned at the factory before dispatch, but they should be checked carefully when received at the site and realigned if necessary. To align the coupling and the shaft, use a straight-edge to check the concentricity and thickness gauges for the angular misalignment.

The 3 figures below show the procedure in detail and the admissible deviations :

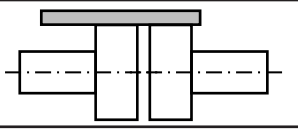
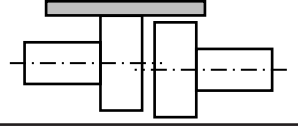
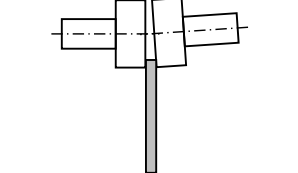
Carry out the control at four points : at the top - at the bottom - left - right	
	Correct
	Bad alignment
	Angular fault

REMINDER :



A flexible coupling does not avoid to do a good alignment.

Controlling the alignment at each stage of the installation is important to be sure that none of the following procedures has generated stresses on the unit or the pump :

- after fastening on the foundations.
- after fastening the pipes.
- after the pump has been operated at the normal operating temperature.

NEVER START A UNIT IF THE COUPLING ALIGNMENT IS INCORRECT. THIS WILL RENDER OUR WARRANTY INVALID.



3.7 Electric motors



 WARNING	DISCONNECT THE ELECTRICITY SUPPLY BEFORE ANY MAINTENANCE OPERATION.
	
Dangerous voltage. Can cause injury and death.	



Check that the supply voltage matches the indications on the motor rating plate.

Comply with the wiring diagram, make sure the wires are rated for the power and take care with the contacts, which must be thoroughly tightened. The motors must be protected by appropriate circuit breakers and fuses. Connect the regulatory ground connections.

Check the direction of rotation :

 WARNING	TAKE ALL NECESSARY MEASURES TO RENDER ANY START-UP, EVEN ACCIDENTAL, OF THE PUMP DURING THE WORK IMPOSSIBLE.
	
Any unforeseen start-up can cause serious injuries or important material damages.	

 WARNING	PUMPS OPERATING AGAINST A CLOSED VALVE CAN CAUSE SYSTEM FAILURE, PERSONAL INJURY AND PROPERTY DAMAGE.
	
Hazardous pressure can cause personal injury or property damage.	

 WARNING	OPERATION WITHOUT THE SHAFT PROTECTOR CAN CAUSE SERIOUS PERSONAL INJURY, MAJOR PROPERTY DAMAGE OR DEATH.
	
Do not operate without guard in place.	

This check should be done with no product being pumped, and both the inlet and discharge circuits vented to avoid generating unexpected pressure (on the inlet side, for example). This will avoid damaging either the pump or the system.

3. INSTALLATION (continued)

Start the pump empty to check that the connections are good and that the direction of rotation corresponds to the system intake and discharge directions. If it is necessary to reverse the direction of rotation, follow the instructions below :

Three-phase motor : switch any 2 current input wires.

Ensure to remove the draining plug (side end motor shaft) when installing the group definitively.



3.8 Sealing of the unit

Refer to Instructions 1011-M00 HOW TO POSITION WEDGES AND HOIST SCREW.



4. STORAGE CONDITIONS

The equipment must be systematically stored in an area sheltered from bad weather.

The equipment must bear its original protective components until it is installed in its final application.

If installation is interrupted, put back in place the original protective components or equivalent components

5. PRODUCTS UNLOADED

	WARNING
	IF PUMPING HAZARDOUS OR TOXIC FLUIDS, THE SYSTEM MUST BE FLUSHED PRIOR TO PERFORMING ANY SERVICE OPERATION.
Toxic or hazardous fluids can cause serious injury.	

5.1 Class of products and installation zone

Keep strictly to the recommendations made in the material definition.



It is the responsibility of the installer to ensure that the CENTREX MULTI 2 unit is compatible with the class of products pumped as well as with the installation zone.



Use an ATEX unit where necessary.



5.2 Compatible products



- All products chemically compatible with the construction, consult us if necessary.
- For example: Diesel, domestic heating oil, nonroad diesel, kerosene, Biofuel...
- Viscosity : see Instructions of the pump (NT 1010-D00) - § OPERATING LIMITS.



6. MAINTENANCE



	WARNING	
		FAILURE TO RELIEVE SYSTEM PRESSURE PRIOR TO PERFORMING PUMP SERVICE OR MAINTENANCE CAN CAUSE PERSONAL INJURY OR PROPERTY DAMAGE.
	Hazardous pressure can cause personal injury or property damage.	

	WARNING	
		TAKE ALL NECESSARY MEASURES TO RENDER ANY START-UP, EVEN ACCIDENTAL, OF THE PUMP DURING THE WORK IMPOSSIBLE.
	Any unforeseen start-up can cause serious injuries or important material damages.	

	WARNING	
		DISCONNECT THE ELECTRICITY SUPPLY BEFORE ANY MAINTENANCE OPERATION.
	Dangerous voltage. Can cause injury and death.	

	WARNING	
		IF PUMPING HAZARDOUS OR TOXIC FLUIDS, THE SYSTEM MUST BE FLUSHED PRIOR TO PERFORMING ANY SERVICE OPERATION.
	Toxic or hazardous fluids can cause serious injury.	

	WARNING	
		HYDRAULIC PRESSURE MUST BE FULLY RELEASED BEFORE MAINTENANCE OPERATIONS IN ORDER TO PREVENT PERSONAL INJURY OR PROPERTY DAMAGE.
	Hazardous pressure can cause personal injury or property damage.	

	WARNING	
		BE CAREFUL WITH THE WEIGHT OF THE PARTS WHEN THEY ARE BEING REMOVED.
	The weight of the parts can be dangerous and may provoke bodily injuries or material damages.	

6.1 Pump

Comply with the instructions leaflet.

6.2 Filters

Clean filters **1**, **4** and **10** regularly.

7. SCRAPPING

The unit must be scrapped in compliance with the regulations in force.

During this operation, particular care must be paid to the drainage stages of the unit.



DECLARATION UE DE CONFORMITE
EU CERTIFICATE OF CONFORMITY – EU KONFORMITÄTSERKLÄRUNG



MOUVEX sas, ZI La Plaine des Isles – 2 Rue des Caillottes – 89000 Auxerre France, déclare que l'équipement suivant / declares the following equipment / erklärt, dass folgende Ausrüstung:

Modèle : _____ (A) Répondant aux spécifications indiquées dans l'ARC N° : _____ (B)
Designation / Bezeichnung Serial N° / Serien Nr According to the specifications recorded in the acknowledgment of order N°:
Entsprechend den Spezifikationen aus AB-Nr :

Pour la Sté MOUVEX sas, fait à Auxerre le : _____
For Mouvex sas company – Date : _____
Für die Fa Mouvex sas - Datum : _____

Responsible Quality Clients
Customer Quality Manager / Qualitätsbeauftragter

- Configuration :**
Konfiguration
- Pompe / Compresseur arbre nu
(Pump / Compressor « bare-shaft »)
(Pumpe / Kompressor, freies Wellenende)
- Groupe de pompage / de compression
(Pumping Unit / Compressor Unit)
(Pumpen- / Kompressoraggregat)
- Type / Geräteart :**
- Pompe à mvt excentré (Eccentric Disc Pump / Ringkolbenpumpe)
 - Pompe péristaltique (Peristaltic Pump / Schlauchpumpe)
 - Pompe centrifuge (Centrifugal Pump / Kreiselpumpe)
 - Compresseur à Vis (Screws compressor / Schraubenverdichter)
 - Compresseur à palettes (Vaness compressor / Flügelzellenverdichter)
 - Refroidisseur Hydraulique (Hydraulic oil cooler / Hydraulikölkühler)
 - Pompe à lobes (Lobes Pump / Drehkolbenpumpe)
 - Pompe à palettes (Vaness Pump / Flügelzellenpumpe)
 - Autre pompe (Other Pump / Andere Pumpe)

Est conforme aux dispositions suivantes :

- Directive « MACHINES » 2006/42/CE et aux législations nationales (à transposer, portant sur les dispositifs de sécurité liés aux risques mécaniques et électriques applicables aux machines tournantes.
NF EN 809:2009 NF EN 1672-2:2009 NF EN ISO 13857:2008
NF EN 12162:2009
- Directive « ATEX » 2014/34/EU du 26 février 2014 et aux législations nationales la transposant; portant sur les appareils destinés à être utilisés en atmosphères explosibles. Conformité obtenue par application des normes :
NF EN 1127-1:1997 NF EN 13463-1:2009 NF EN 13463-5:2009
Certification ATEX délivrée par INERIS*, Organisme Certificateur, et portant le marquage suivant : (C)

Is in conformity with the provisions of the following Directive:

- « MACHINES » Directive 2006/42/EEC as transposed by the national legislation, concerning safety equipments and arrangements relative to mechanical and electric risks applicable to rotative machines.
NF EN 809:2009 NF EN 1672-2:2009 NF EN ISO 13857:2008
NF EN 12162:2009
- « ATEX » Directive 2014/34/EU (26 Feb. 2014) as transposed by the national legislation, concerning equipment intended to be used in explosive atmospheres. Conformity obtained by application of the standards :
NF EN 1127-1:1997 NF EN 13463-1:2009 NF EN 13463-5:2009
ATEX Certification delivered by INERIS*, Notified Body, and with the following marking: (C)

den Bestimmungen der nachstehenden Richtlinien entspricht:

- „Machines-Richtlinie“ 2006/42/EEC wie umgesetzt im nationalen Recht hinsichtlich der Ausrüstungssicherheit und Sicherheitsvorkehrungen bezogen auf mechanische und elektrische Risiken, die für rotierende Maschinen gelten.
NF EN 809:2009 NF EN 1672-2:2009 NF EN ISO 13857:2008
NF EN 12162:2009
- „ATEX“ Richtlinie 2014/34/EU (26. Feb. 2014) wie umgesetzt im nationalen Recht in Bezug auf Ausrüstungen für den Einsatz in explosionsgefährdeter Atmosphäre. Die Konformität hat Geltung durch Anwendung folgender Normen:
NF EN 1127-1:1997 NF EN 13463-1:2009 NF EN 13463-5:2009
Die ATEX-Zertifizierung wurde von der benannten Stelle INERIS* erteilt, und mit folgender Kennzeichnung: (C)



Temp Max produit pompé / Max Temp Flow / Max. T° Medium = _____ °C (X = voir notice / see IOM / siehe Handbuch)

L'équipement désigné ci-dessus doit impérativement respecter les conditions d'utilisation ATEX décrites dans nos notices d'instruction. Il doit être employé conformément à l'utilisation qui en a été prévue de par sa conception et sa fabrication, et conformément aux normes en vigueur. Nous, soussignés, déclarons que l'équipement concerné est conforme aux Directives listées ci-dessus et aux normes applicables s'y rapportant.

The equipment indicated above must imperatively comply with the ATEX conditions of use described in our instruction book. It must be used according to the foreseen use by its design and its manufacturing, and according to the current standards. We, undersigned, declare that the concerned equipment is in conformity with the Directives listed above and in the applicable standards in force.

Oben stehend bezeichnete Ausrüstung muss unbedingt den in unseren Betriebsanleitungen beschriebenen ATEX Anwendungsbedingungen entsprechen. Sie ist entsprechend dem durch Konstruktion und Fabrikation vorgesehenen Verwendungszweck und entsprechend den geltenden Normen einzusetzen. Die Unterzeichner erklären, dass die bezeichnete Ausrüstung den oben aufgeführten Richtlinien und den diesbezüglich geltenden Normen entspricht.

CTRL-D025 – rév.04 du 25/05/2016 – Déclaration de conformité CE-Atex

* (INERIS – Parc Techno Alata – 60550 Verneuil-en-Halatte – France).