

WG

EOM

Engineering
Operation &
Maintenance

Leak Detector



Advance your process



WILDEN
A DOVER COMPANY

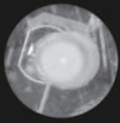

WIL-GARD III
DIAPHRAGM MONITORING SYSTEM

- Blinking red light and audible alarm indicates leak.
- Must be reset internally after a leak is detected.
- Sensors and diaphragms must be replaced after contact with the pumping medium.

65-8015-99

WIL-GARD III
DIAPHRAGM MONITORING SYSTEM

WILDEN

A DOVER COMPANY

WIL-19050-E-02
TO REPLACE WIL-19050-E-01

SENSOR CABLE SPECIFICATIONS

The sensor cables utilize high Beryllium content ultra fine strand copper wire to remain sensitive even when subjected to millions of pump strokes in a dynamic environment. PTFE and PFA materials are used for insulation, binder, and jacket to provide exceptional chemical resistance.

Conductivity Threshold: 75 micro-Siemens
 Length of sensor cables: 36" (0.91m)
 Length of extension cords: 100' (30.48m)
 (See page 6)
 Connectors: Sealed. Housed in composite material — Ultem®

CROSS SECTION OF SENSOR CABLE

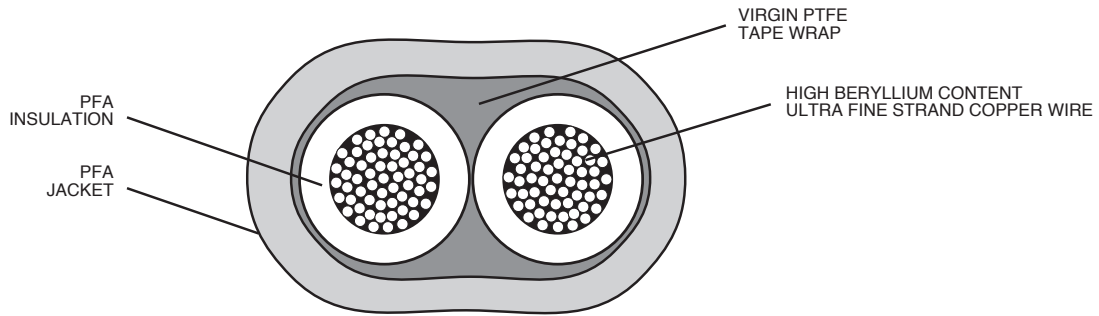

INSTALLATION OF SENSOR CABLE

Care should be used during the installation process to protect the sensor from being exposed to fluid, or from fluid being trapped between the diaphragms.

1. The location of the sensor wire ends shall be between the outer PTFE diaphragms and the inner back-up diaphragms on both sides of unit being assembled.
2. The sensor wire end should be 1/3 of the way between the outer edge and the center hole of the diaphragm. (Note: See chart [below right] for precise measurement.)
3. Sensor wire ends shall be inserted to the 6:00 position and channeled out of the unit to the 3:00 position on the air valve side.

To ensure proper sealing and operation, torque outer pistons to proper specification. The wires should be routed straight down and along the outside of the liquid chamber under the clamp band. Refer to illustration (Figure 1). Refer to pump operation and maintenance manual for usage of expanded PTFE gasket material to seal between PTFE primary diaphragm and liquid chamber.

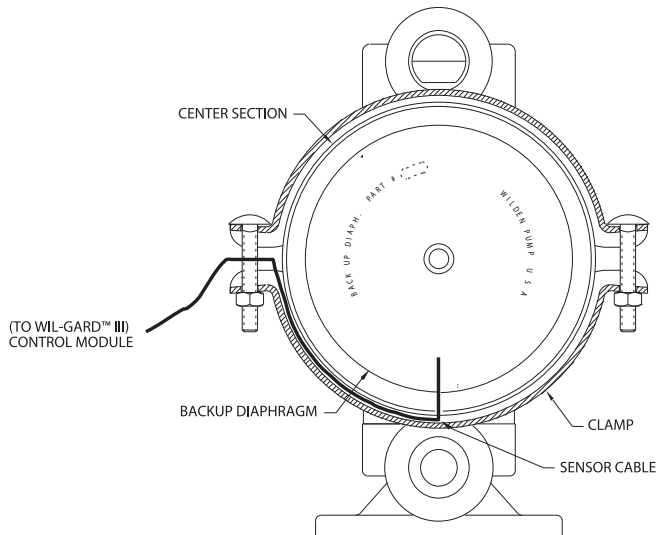

Figure 1 SIDE VIEW OF PUMP

Sensor Wire Insertion Chart	
Pump Size	Inches
13 mm (1/2")	1"
25 mm (1")	1 1/4"
38 mm (1 1/2")	1 1/2"
51 mm (2")	2"
76 mm (3")	2 1/3"
102 mm (4")	2 1/3"

INSTALLATION

The Wil-Gard™ III is designed for use with Wilden two-piece diaphragms that use a primary and backup diaphragm on each side of the pump. The system cannot be used with single-piece rubber or thermoplastic primary diaphragms that do not have a backup diaphragm. This unit can be purchased as a factory installed option in the Wilden pump or as an accessory to be installed in existing pumps. The NEMA 4X enclosure is constructed of Polycarbonate with stainless steel screws, nylon cable grip, and polycarbonate label.

The Wil-Gard™ III can be powered by a variety of electrical sources by using the supplied power adaptors (100-240 VAC, 50/60 Hz).

The control module is splash resistant, but should be mounted in a dry, safe, accessible location. Upon completion of installation, verify the integrity of all connections. Cable grip, lid, and all wiring connections should be secure to assure proper operation.

The Wil-Gard™ III system alone is designed to detect diaphragm failure. However, with the addition of a few electric components, it is simple to use the detection

features of the module to actively intervene when diaphragm failure occurs. In most applications, the internal relay (2 amp, 125 volts max.) is used to direct power to a solenoid valve installed on the pump air inlet, which suspends pump operation when failure occurs. In some situations, it is appropriate to isolate the inlet and discharge piping from the pump to prevent product contamination or product containment.

The sensors should be protected from fluids prior to and during installation. If the sensor comes into contact with a fluid prior to installation it may not perform as designed. Please refer to page 2 for the installation of the diaphragm and sensor cable.

CAUTION: Do not expose sensor to fluids before sensor is installed in pump.

Sensors cannot be reused. Back-up diaphragms and sensor cables must be replaced when primary diaphragm failure occurs.

INSTALLATION OF SENSOR RECEPTACLE AND EXTENSION CORDS

Once the sensor cables have been installed within the pump as discussed on page 1, they must be connected to the control module via the sensor receptacle which is factory installed. The sensor cables are connected to the sensor receptacle by simply inserting the in-line plug into the receptacle, aligning the key notch, and turning the connector clockwise one-half turn until a click is heard.

If the sensor cables extending from the pump are not long enough to reach the control module, the user can lengthen the wiring with a 100' (30.48m) extension cord(s) available from Wilden. These extension cords utilize the same connectors as the sensor cable and receptacle for compatibility and ease of use (see Fig. 2). In lieu of the Wilden extension cords, the user may supply his own wire (AWG 24) up to 500 feet (152m). It is critical that the Wilden sensor cable is installed in the pump for proper operation.

It is important that all wiring connections are waterproof and secure. It may be necessary to run all wiring through conduit. The cable grip located on the bottom of the control module should be tightened so that the penetration is resistant to liquid intrusion.

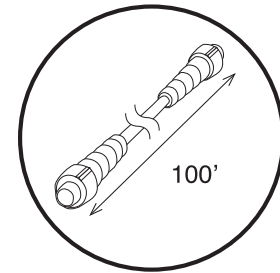

Figure 2

INSTALLATION OF EXTERNAL COMPONENTS TO INTERNAL RELAY

There is a single-pole, double-throw (SPDT) relay on the control module circuit board. The relay is provided so that external components can be controlled by the module.

External wiring can be connected to this relay through the screw terminals on the edge of the circuit board. The relay is energized and the common (COM.) pole is connected to the normally open (N.O.) pole when the module is energized and a diaphragm failure is not detected. When an alarm occurs or power is lost, the relay is de-energized and the common (COM.) pole is connected to the normally closed (N.C.) pole. The relay rating is 2 Amps at 125 Volts. Therefore, to attach more than one component or a large inductive load, it may be necessary to use the internal relay to drive an external multi-pole relay which can handle more components and/or higher amperage (See Fig. 3).

ALARM INITIATION • RELAY CLOSURE • COMPONENT ACTIVATION

Figure 3

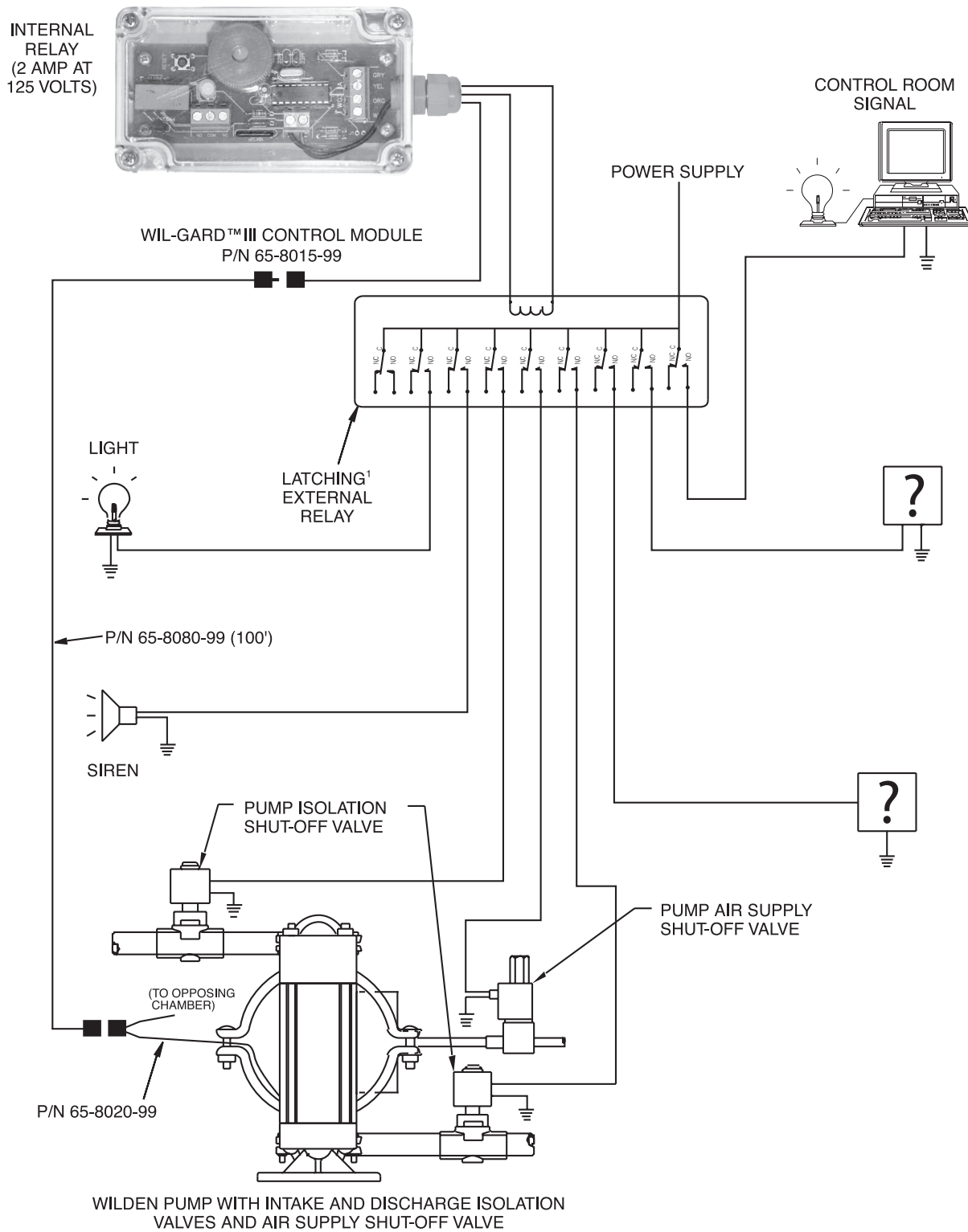

¹EXTERNAL RELAY NEEDED ONLY WHEN COMPONENT(S) CONNECTED TO INTERNAL RELAY HAVE AN AMPERAGE LARGER THAN 2 AMPS AT 125 VOLTS.

TROUBLESHOOTING

Audible alarm, LED and relay do not activate upon diaphragm failure.

- 6" wire receptacle is not connected correctly to the control module terminal block.
- Sensor wires (P/N 65-8020-99), 6" receptacle and/or the extension cords are crushed or broken.
- Verify the integrity of the 4 pin connector.
- Verify the sensor wire placement within the pump.
- Check the sensor for contamination; sensors cannot be reused.

Wil-Gard™ III functioned correctly upon diaphragm failure, not noticed by personnel.

- Install external alarm system to internal relay.
- Install solenoid valve to provide active intervention upon diaphragm failure.
- Utilize latching, external relay to ensure intervention.

Unit is alarming, but diaphragm has not failed.

- Verify the torque specification of the outer piston.
- Verify the torque specification of the clamp bands.
- Verify that new expanded PTFE gasket kit on liquid chambers was utilized upon installation.
- Check the ends of the sensor wire to ensure that the two copper conductors are not touching. In some cases, it may be desirable to remove a 0.5" (13mm) portion of the jacket and tape wrap and separate the two conductors by a small distance to prevent inadvertent contact.

CONDUCTIVE LIQUIDS – AN OVERVIEW

Liquids that conduct an electrical charge are said to be conductive. Conductive liquids may contain a percentage of water and are usually inorganic. For example, acids and caustics are typically conductive, whereas solvents and hydrocarbons in 100% concentration are typically non-conductive.

The introduction of a conductive liquid such as ordinary water will introduce conductivity to non-conductive liquids. For any given non-conductive liquid, it is not possible to predict the volume of conductive media which must be added to result in a conductive liquid. Therefore, a conductivity test must be performed to verify that the Wil-Gard™ III will detect

the process fluid upon diaphragm failure. The test for conductivity can be performed in two ways:

- 1) Contact your authorized Wilden distributor for an on-site review. In this event, the actual sensor cable of the Wil-Gard™ III is dipped into the process fluid in question, to determine whether the conductivity of the process fluid is sufficient for detection.
- 2) A conductivity meter can be utilized to measure the conductivity of the process fluid. The Wil-Gard™ III will detect any fluid that has a conductivity of more than 75 micro-Siemens.

MODEL NUMBER, OPTIONAL AND REPLACEMENT PARTS

WIL-GARD™ III KIT: **65-8115-99**

Kit includes:

Wil-Gard™ III Control Module	65-8015-99
Wil-Gard™ III Conductive Sensor Cables	65-8020-99

Replacement Parts

Wil-Gard™ III Control Module	65-8015-99
Wil-Gard™ III Conductive Sensor Cables	65-8020-99
Wil-Gard™ III 6" Wire w/Inline Receptacle	65-8050-99

Optional Parts

100' PE Extension w/In-Line Receptacle & Plug	65-8080-99
---	------------

NOTES:

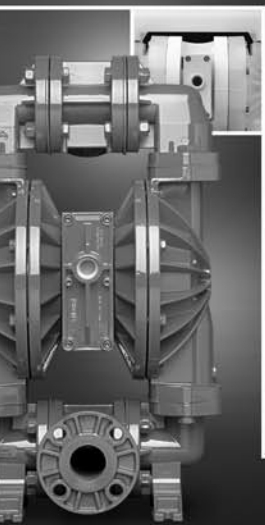

ADVANCED S E R I E S

Advance Your Process

- Advanced wetted path designs
- Lower the cost of operation
- Maximize product containment
- Longer MTBF (Mean Time Between Failures)
- Enhanced internal clearance
- The result of advanced thought

UNITEC S E R I E S

Enrich Your Process

- Simplicity of design
- Unique Technology
- Reliable, leak-free & quiet
- Validated & certified
- Intrinsically safe
- The result of unique thought

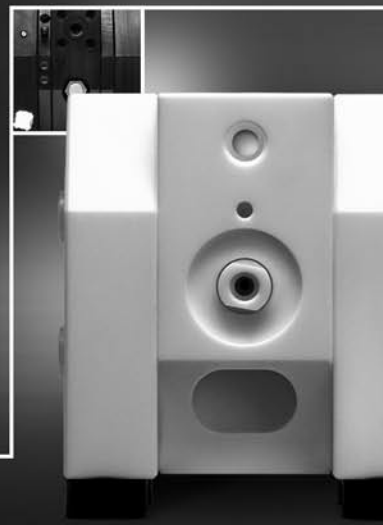

SANIFLO SANITARY PUMP TECHNOLOGY

Refine Your Process

- Designed for sanitary applications
- Minimize product degradation
- Improved production yields
- Easy to inspect, clean & assemble
- Minimized water requirements
- The result of progressive thought

ACCESSORIES

Maximize Your Process

- Electronic control & monitoring
- Level control & containment
- Pulsation dampening
- Drum unloading systems
- Complete system solutions
- The result of innovative thought

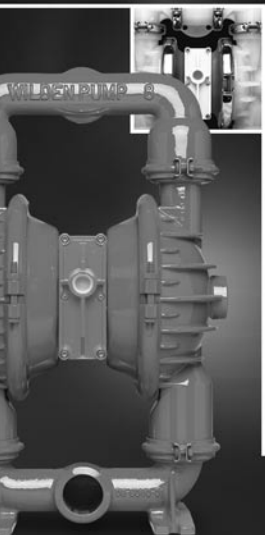

ORIGINAL S E R I E S

Simplify Your Process

- Long standing design simplicity
- Portable & submersible
- Variable connection options
- Fewest parts in industry
- Solutions since 1955
- The result of original thought



WILDEN[®]

A **DOVER** COMPANY

22069 VAN BUREN STREET • GRAND TERRACE, CA 92313-5607
(909) 422-1730 • FAX (909) 783-3440
www.wildenpump.com

Your Local Authorized Distributor: