

EOM

ENGINEERING OPERATION
& MAINTENANCE MANUAL

PCMI Pump Cycle Monitor

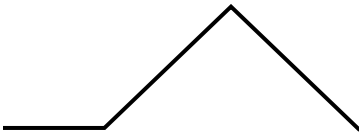

Where Innovation Flows

WILDEN®

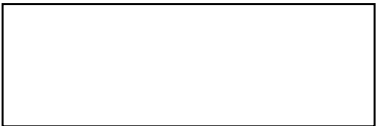

Copyright

Copyright 2015 PSG®, a Dover Company. All rights reserved.

PSG reserves the right to modify the information and illustrations in this document without prior notice. The product described in this document is furnished under a license agreement or nondisclosure agreement. No part of this document may be reproduced, stored in a retrieval system, or transmitted in any form or any means electronic or mechanical, including photocopying and recording, without the written permission of PSG, a Dover Company, except as described by the terms of those agreements.

This is a non-contractual document.

Trademarks

PSG and the PSG logo are registered trademarks of PSG. Wilden® is a registered trademark of PSG California LLC. Pro-Flo® SHIFT and Pro-Flo® are registered trademarks of PSG California LLC. Wil-Flex® is a trademark of PSG California LLC. Saniflex™ is a trademark of PSG California LLC.

All trademarks, names, logos and service marks (collectively “trademarks”) in this document are registered and unregistered trademarks of their respective owners. Nothing contained in this document should be construed as granting any license or right to use any trademark without the prior written permission of the trademark owner.

Warranty

Each and every product manufactured by Wilden is built to meet the highest standards of quality. Every pump is functionally tested to ensure integrity of operation. Wilden warrants that pumps, accessories and parts manufactured or supplied by it to be free from defects in material and workmanship for a period of five (5) years from date of installation or six (6) years from date of manufacture, whichever comes first.

For more information, and to register your Wilden pump for warranty, please visit <https://www.psgdover.com/wilden/support/warranty-registration>.

CONTENTS

SECTION 1: Precautions – Read First! 4

SECTION 2: How It Works 5

SECTION 3: Dimensional Drawing 6









SECTION 4: Suggested Installation and Troubleshooting 7

SECTION 5: Reassembly 9

SECTION 6: Parts List..... 11

SECTION 1

PRECAUTIONS – READ FIRST!

-  **WARNING:** Always wear safety glasses when operating a pump to avoid eye injury. If diaphragm rupture occurs, material being pumped may be forced out of the air exhaust.
-  **CAUTION:** Before attempting any maintenance or repair, disconnect the compressed air line to the pump and allow all air pressure to bleed from the pump. Disconnect all intake, discharge, and air lines. Drain the pump by turning it upside down and allowing any fluid to flow into a suitable container. Be aware of any hazardous effects of contact with your process fluid.
-  **WARNING:** Do not recharge, disassemble, crush or expose lithium power cell to temperatures above 100°C (212°F)
-  **CAUTION:** When removing the end cap using compressed air, the air valve end cap may come out with considerable force. Hand protection such as a padded glove or rag should be used to capture the end cap.
-  **CAUTION:** Use caution when mounting the PCMI enclosure in areas where wash down occurs.
- !** **NOTE:** The PCMI is to be used with Wilden sensor and embedded air valve spool magnet ONLY.
-  **CAUTION:** When adding a remote resetting switch, ensure that 24-gauge wire or larger is used and that the remote switch is mounted within 250 feet of the PCMI.
-  **CAUTION:** The PCMI enclosure must be mounted within 250 feet of the pump to ensure proper operation.
-  **CAUTION:** Penetrating the PCMI enclosure for mounting purposes or to install additional wiring will negate the NEMA 4X enclosure rating.
-  **WARNING:** This product can expose you to chemicals including Nickel, Chromium, Cadmium, or Cobalt, which are known to the State of California to cause cancer and/or birth defects or other reproductive harm. For more information, go to www.P65Warnings.ca.gov.

SECTION 2

HOW IT WORKS



The PCMI counts pump cycles by sensing the presence of the Pro-Flo® and Pro-Flo® SHIFT air valve spool. The sensor, located at the air valve end cap, detects the presence of a magnet located at the end of the air valve spool. The PCMI unit registers a complete pump cycle when the spool shifts away from the sensor and subsequently returns to the original position. The counter resets itself to zero automatically after reaching 100 million cycles. The PCMI has a reset switch located on the face of the PCMI module that can be activated to allow “on the spot” resetting of the counter or disabled to prevent inadvertent loss of data. The unit also has the ability to be reset from a remote location.

SECTION 3

DIMENSIONAL DRAWING

PCMI

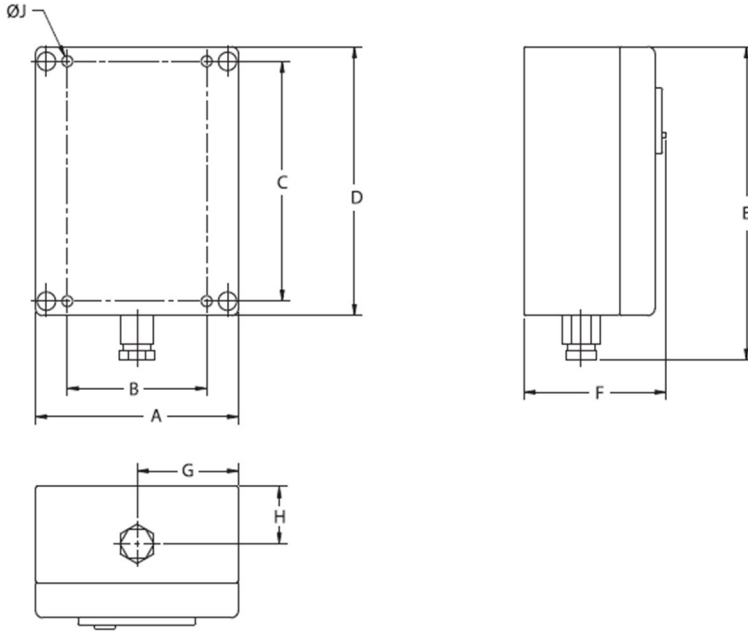

DIMENSIONS

ITEM	METRIC (mm)	STANDARD (inch)
A	86	3.4
B	61	2.4
C	104	4.1
D	117	4.6
E	135	5.3
F	61	2.4
G	43	1.7
H	25	1.0
J	5 DIA.	0.2 DIA.

LW0224, REV A

SECTION 4

SUGGESTED INSTALLATION AND TROUBLESHOOTING

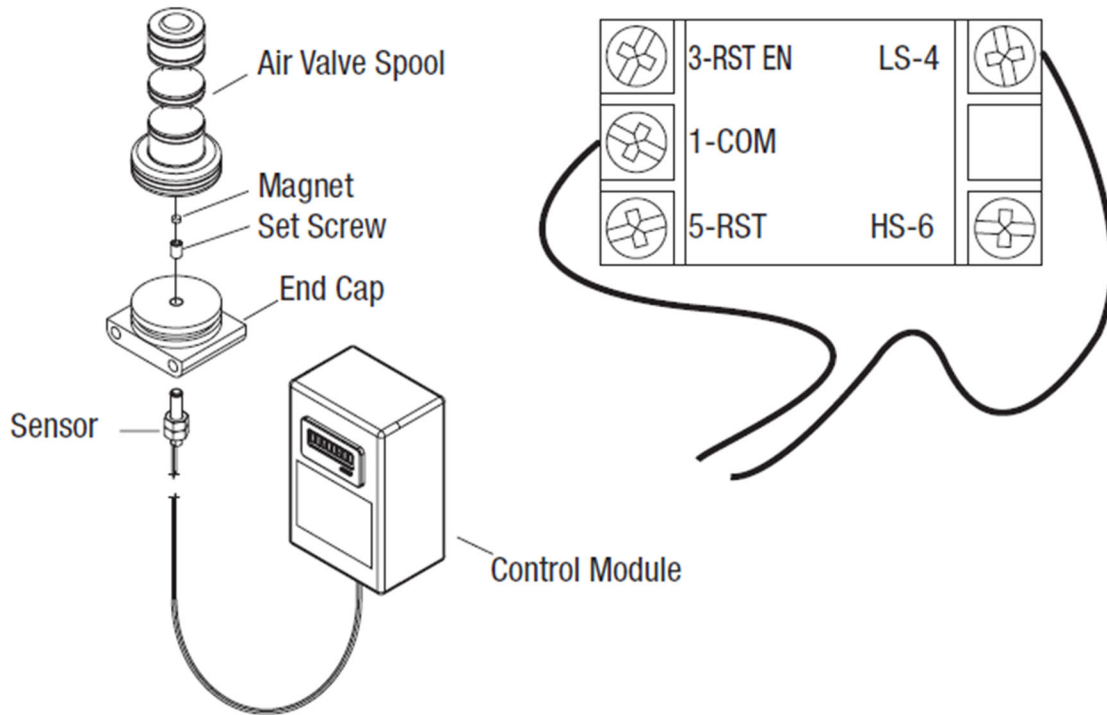

The PCMI is designed for use with Wilden Pro-Flo® and Pro-Flo® SHIFT pump models. The PCMI unit can be purchased as a factory installed option in the Wilden Pro-Flo and Pro-Flo SHIFT pump or as an accessory to be installed in existing Wilden Pro-Flo and Pro-Flo SHIFT.

If this system is purchased with a Wilden Pump, an air valve fitted with a sensor will already be attached to your pump. When purchased separately, you will have to remove the existing air valve and attach the new air valve, which is equipped with a sensor.

To mount the PCMI enclosure, simply remove the front cover and insert a screw into the mounting holes located in each corner of the enclosure.

Use caution when mounting the module in a wash-down area to minimize exposure to moisture.

Proper care should be taken not to penetrate the PCMI enclosure, as this will invalidate the NEMA 4X rating.

To connect the sensor wires to PCMI module, secure wires to wire terminals 1 (COM) and 4 (LS) at the back of the LCD display.

The wiring can be extended up to 250 feet for ease of installation.

To enable the front panel reset button, simply connect a wire between terminals 1 (COM) and 3 (RST EN). A momentary switch can be connected to terminals 1 (COM) and 5 (RST) for remote reset.

SUGGESTED INSTALLATION AND TROUBLESHOOTING

Troubleshooting

Pump is running, but the PCMI is not counting cycles.

1. Check to make sure that the sensor wiring is secured to the proper wiring terminals to the back of the LCD display on the cover of the module enclosure. The correct wiring terminals are as follows: LS-R and 1-com.
2. Check to ensure that the sensor wiring that connects the sensor to the PCMI module is not cut, broken or damaged.
3. Check to ensure that the magnet located at the top end of the air valve spool is secured to the end cap and has not become loose.
4. Check to ensure that the pump is operating properly and that no mechanical malfunction has occurred.
5. Check to ensure that discharge pressure is not greater than inlet air pressure and that discharge piping is free from obstruction.
6. Check to ensure that the sensor is not damaged.
7. If necessary, replace lithium power cell. Replace lithium power cell by removing back cover of LCD display unit.

SECTION 5

REASSEMBLY

PCMI REASSEMBLY

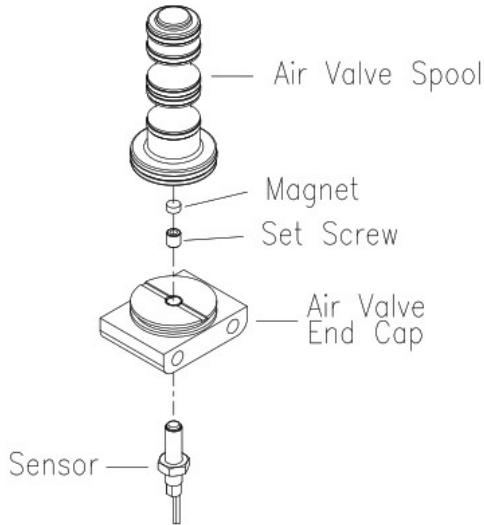

For detailed instructions on the disassembly/reassembly of your pump's air valve, please refer to the pump's manual.

If the Set Screw is removed from the Air Valve Spool and/or the Sensor is removed from the Air Valve End Cap, reassemble the components per the following instructions:

SET SCREW REASSEMBLY

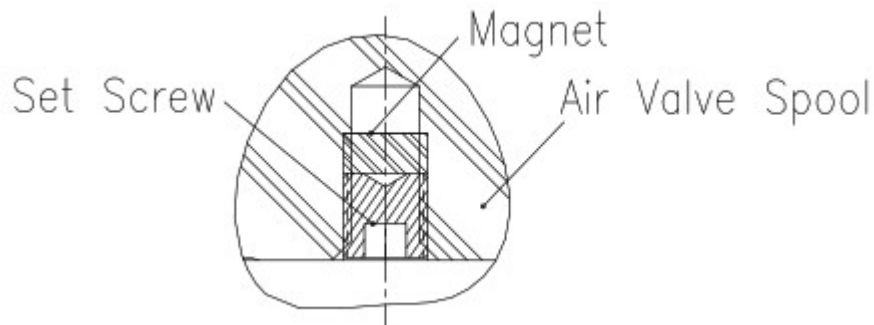

Step 1

Position the Magnet on the Set Screw, as shown above.

Step 2

Apply one (1) drop of Loctite 425 Assure Plastic Fastener Blue Threadlocker* to the Set Screw threads.

*Loctite 425 Assure Plastic Fastener Blue Threadlocker is a fast setting, low strength adhesive commonly used for threadlocking and retention where metals and plastics are used. Assembled parts may be handled in 2 minutes. 24-hour cure is required for full chemical/solvent resistance.

NOTE: To avoid potential damage to the plastic components, use only Loctite 425, as specified.

Step 3

Immediately install the Set Screw into the Air Valve Spool, positioning it flush +/- 1/2 turn to the face of the Spool, as shown.

REASSEMBLY

SENSOR REASSEMBLY

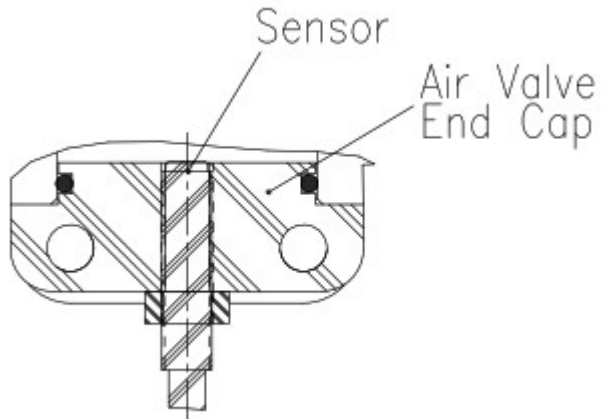
**Step 1**

Apply one (1) drop of Loctite 425 Assure Plastic Fastener Blue Threadlocker* to the Sensor threads.

*Loctite 425 Assure Plastic Fastener Blue Threadlocker is a fast setting, low strength adhesive commonly used for threadlocking and retention where metals and plastics are used. Assembled parts may be handled in 2 minutes. 24-hour cure is required for full chemical/solvent resistance.

NOTE: To avoid potential damage to the plastic components, use only Loctite 425, as specified.

Step 2

Immediately install the Sensor into the Air Valve End Cap, positioning it flush $\pm 1/2$ turn to the face of the End Cap, as shown above.

SECTION 6

PARTS LIST

Part Description	Pump Type	Part No.
Assy, Air Valve, P1/P2, PCMI	P1 & P2	01-2011-13
End Cap, P1/P2, PCMI	P1 & P2	01-2333-13
Assy, Air Valve, P1/P2, PCMI	P1 & P2	01-2011-20
End Cap, P1/P2, PCMI	P1 & P2	01-2333-20
ASSY, AIR VALVE, PX1, PCMI	PX1	01-2031-01
ASSY, AIR VALVE, PX2, PCMI	PX2	02-2031-01
End Cap, PX1/PX2, PCMI	PX1 & PX2	01-2343-01
Assy, Air Valve, P4/P8, PCMI	P4 & P8	04-2011-20
End Cap, P4/P8, PCMI	P4 & P8	04-2333-20
Assy, Air Valve, P15, PCMI	P15	15-2011-20
End Cap, P15, PCMI	P15	15-2333-20
Assy, Air Valve, PV4-PV15,PCMI	PV4, PV8, PV15, PX4, PX8 & PX15	04-2031-01
End Cap, PV4/PX4, PCMI	PV4, PV8, PV15, PX4, PX8 & PX15	04-2343-01
ASSY, AIR VALVE, PV4-PV15,PCMI	PV4, PV8, PV15, PX4, PX8 & PX15	04-2031-03
End Cap, PV4/PX4, PCMI	PV4, PV8, PV15, PX4, PX8 & PX15	04-2343-03
ASSY, AIR VALVE, PX4-15, PCMI	PX4, PX8 & PX15	08-2031-20
End Cap, P4/P8, PCMI	PX4, PX8 & PX15	04-2333-20
ASSY, AIR VALVE, PS 4-15, PCMI	PS4, PS8 & PS15	04-2038-01
End Cap, PV/PX4, PCMI	PX4, PX8 & PX15	04-2343-01
ASSY, AIR VALVE, PS4, ANO PCMI	PS4, PS8 & PS15	04-2038-11
End Cap, PV/PX4, PCMI	PS4, PS8 & PS15	04-2343-01
Set Screw, Shcp, 1/4"-20	ALL but P15	99-6340-08
Set Screw, Shcp, 7/16"-14	P15	99-6341-08
PCMI Counter	ALL	99-8150-99
Magnet, Round, Ndfcb, .375	ALL	99-8321-99
Sensor W/ 36" Leads	ALL	99-8330-99

WILDEN®

PSG
22069 Van Buren Street
Grand Terrace, CA 92313-5651 USA
P: +1 (909) 422 -1730
psgdover.com



Where Innovation Flows

PSG® reserves the right to modify the information and illustrations contained in this document without prior notice. This is a non-contractual document.