

Positive displacement meters series **SBM 75 - SBM 150**



SBM 150 with VEGA T



SBM 75 CF

www.isoilmeter.com



SBM 150 with VEGA T



SBM 75 CF+Check

Positive displacement meters series SBM 75 - SBM 150

ISOIL PD meter series **SBM** sizes 2" and 3" offers high accuracy: $\pm 0.1\%$ (SBM 150) and $\pm 0.15\%$ (SBM 75) with a repeatability better than $\pm 0.02\%$, over a large range of flow rate. This accuracy remains constant during long periods of use. Visual indication of the flow rate measured can be obtained when associated with mechanical register or electronic flow computer directly mounted on the meter or remote by means of a pulses emitter (see VEGA II or VEGA T leaflets).

Operation

While rotating, the vanes are driven by the internal surface of the single body. This means that the self-lubricating vanes are always in contact with the internal surface of measuring chamber, therefore product leakage is avoided and though high accuracy is granted.

The calibration mechanism allows micrometric adjustment. It is not necessary to change gears.

When an electronic counter is used, the calibration mechanism is substituted with a 90° driving gear, if the electronic counter is mounted directly on the meter. If the electronic counter is remote, the meter mounts a pulses emitter or encoder (see Encoder Isoil 6422 data sheet).

Applications

- » tank trucks loading and unloading
- » biofuel Blending
- » aircraft refuelling
- » petrochemical products transfer in refineries, loading terminals and pipelines
- » calibration of other meters or tanks (Master Meters)

Filtering and air elimination

To assure a measuring accuracy and preserve the meter from damage, the fluid under measurement must be properly filtered and air or gas must be eliminated. Isoil produces a wide range of strainers and strainer-air separators.

Accessories

- » pulses emitters: Encoder 6422 Ex-d. Pulses emitter EM 345 Eex-i incorporated in Veeder Root 7887 register
- » with VEGA II or VEGA T, compensation is achieved by an algorithm based on "alfa" coefficient or density
- » unit drum (for Master Meter): allows the reading of the tens of litre
- » instant flow rate indicator: Mechanical needle indicator
- » ticket printer: Veeder Root. Zero start or cumulative
- » preset register: Veeder Root 7889, with one or two pneumatic micro switches or electric micro switches Eex-d ATEX
- » extension for electronic or mechanical counter: L= 250 mm and 500 mm
- » preset valve : 2" and 3"
- » air check valve: 2" and 3"

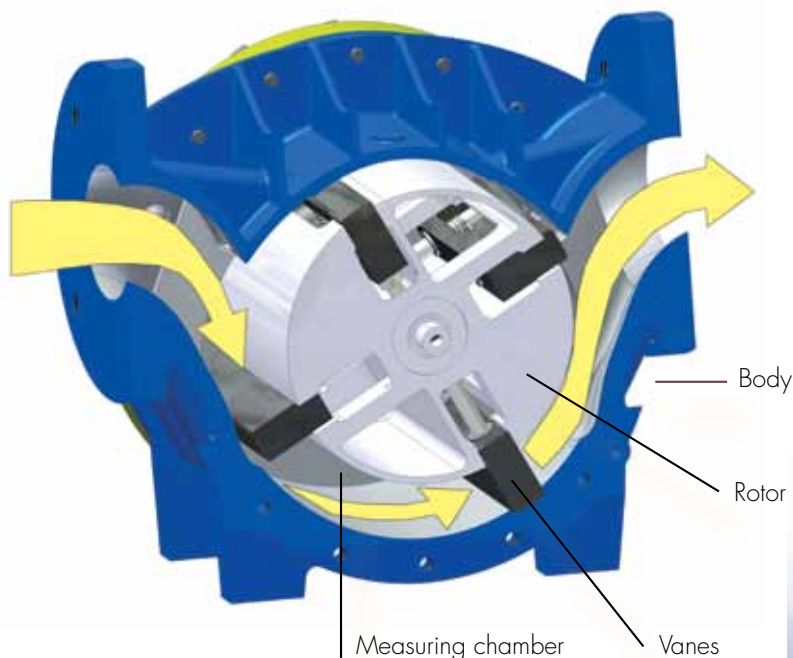

Accuracy curves

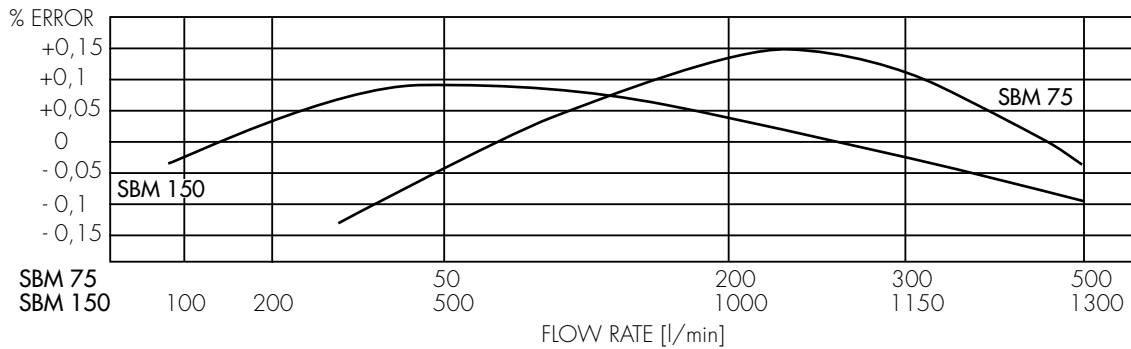

Pressure drop curves

Viscosity at 15°C: 2 cSt
Density: 795 Kg/m³

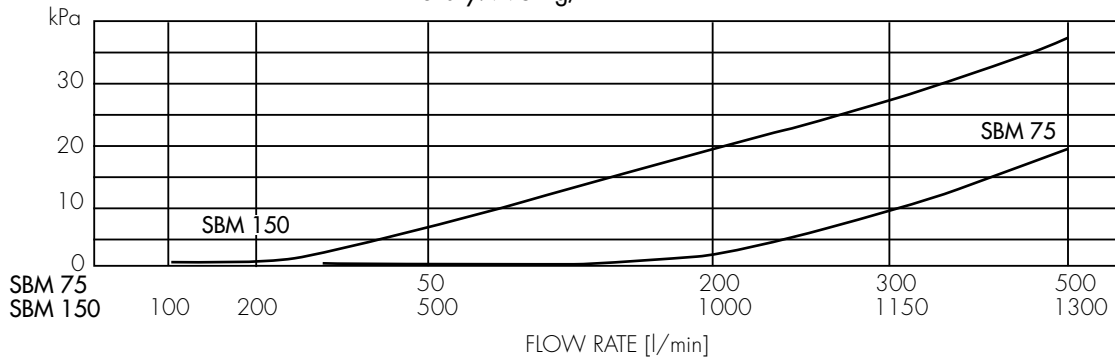

Technical specifications

	STANDARD		UPON REQUEST
	SBM 75	SBM 150	
EU Directives compliance			
PED (dir. 97/23/CE)	Compliant directive 97/23/CE, with risk category depending on the measured liquid		
ATEX (dir. 94/9/CE)	Non electrical equipment, compliant directive 94/9/CE, suitable for installation in hazardous area II 2G, marking Ex II 2 G c T1 ... T6		
Working conditions			
Flow rate:	[50 ; 500] l/min @ 10 cSt	[100 ; 1,300] l/min @ 10 cSt	
Maximum flow rate avio:	600 l/min	1,400 l/min	
Working pressure:	1,000 KPa max	1,000 KPa max	Higher values
Test pressure:	1,700 KPa	1,700 KPa	Higher values
Working temperature:	[-30; +100] °C	[-30; +100] °C	Higher and lower values on request
Construction			
Manifold and flanges:	Aluminium	Aluminium	
Body:	Aluminium	Aluminium	
Covers:	Carbon steel with corrosion prevention treatment	Carbon steel with corrosion prevention treatment	
Rotor:	Aluminium	Aluminium	
Vanes:	Xenia (T _s 60°C)	Graphite	PTFE or graphite (SBM75) (T>60°)
Gaskets:	Nitrile	Nitrile	Viton or PTFE
Ball bearings:	Stainless Steel	Stainless Steel	Graphite bushes
Seal:	Viton lip seal	Viton lip seal	Mechanical seal or magnetic drive
Flanged:	Square 90x90 mm	3" ANSI150 FF	2" ANSI150 RF (SBM75) square 120 x 120 mm (SBM150)
Readout (with mechanical register)	litres	litres	Others upon request
Volume per revolution:	0.625 litres	2.2797 litres	
Flow direction:	Left (IN) to right (OUT)	Left (IN) to right (OUT)	Right (IN) to left (OUT)
Performances			
Accuracy:	± 0.15%	± 0.1%	
Repeatability:	± 0.02%	± 0.02%	
Pressure drop:	Refer to the diagram attached	Refer to the diagram attached	

Terminal version

C = "Counter" V/R 7887
 F = Strainer-airseparator
 P = Preset
 Vp = Preset valve
 Vm = Manual valve
 S = Printer V/R
 Check = Check valve

SBM 75

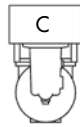

0) MOD: C

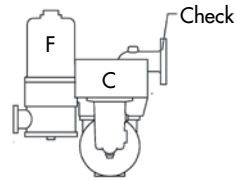

1) MOD: CF + check

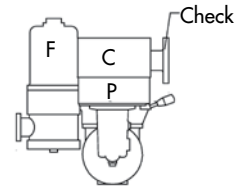

2) MOD: CFP + check

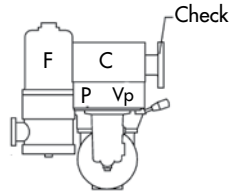

3) MOD: CFPV + check

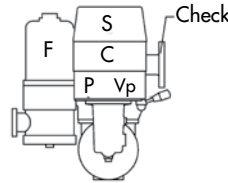

4) MOD: CFPpS + check

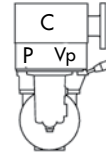

5) MOD: CPVp

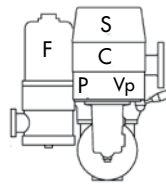

6) MOD: CPVpS

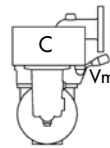

7) MOD: CVm

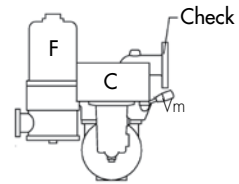

8) MOD: CFVm + check

SBM 150

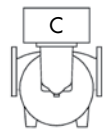

0) MOD: C

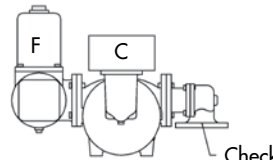

1) MOD: CF + check

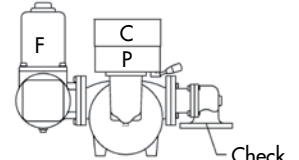

2) MOD: CFP + check

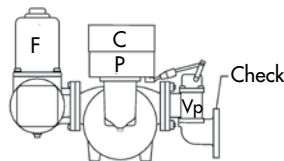

3) MOD: CFPVp + check

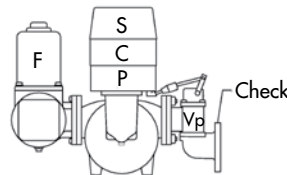

4) MOD: CFPVpS + check

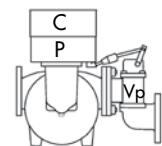

5) MOD: CPVp

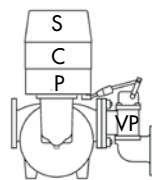

6) MOD: CPVpS

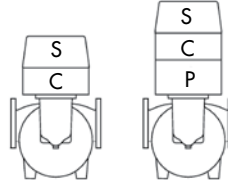

7) MOD: CS

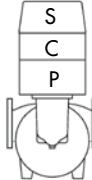

8) MOD: CPS

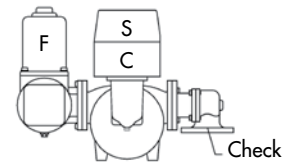

9) MOD: CFS + check



SBM 75

- 1) P.D. Meter
- 2) Strainer-air separator
- 3) Preset valve
- 4) Check valve
- 5) Counter
- 6) Printer
- 7) Preset

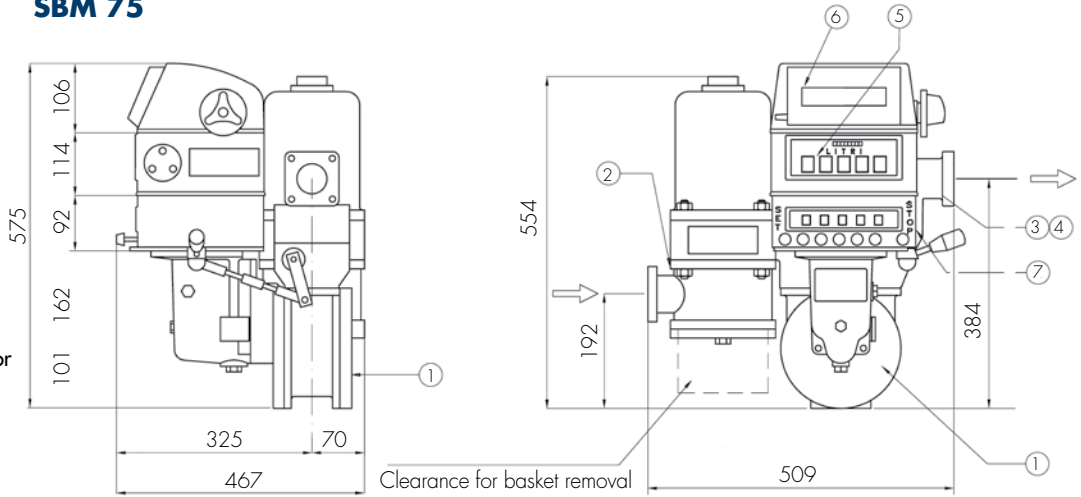

SBM 150

- 1) P.D. Meter
- 2) Strainer-air separator
- 3) Counter
- 4) Preset
- 5) Printer
- 6) Preset valve
- 7) Check valve

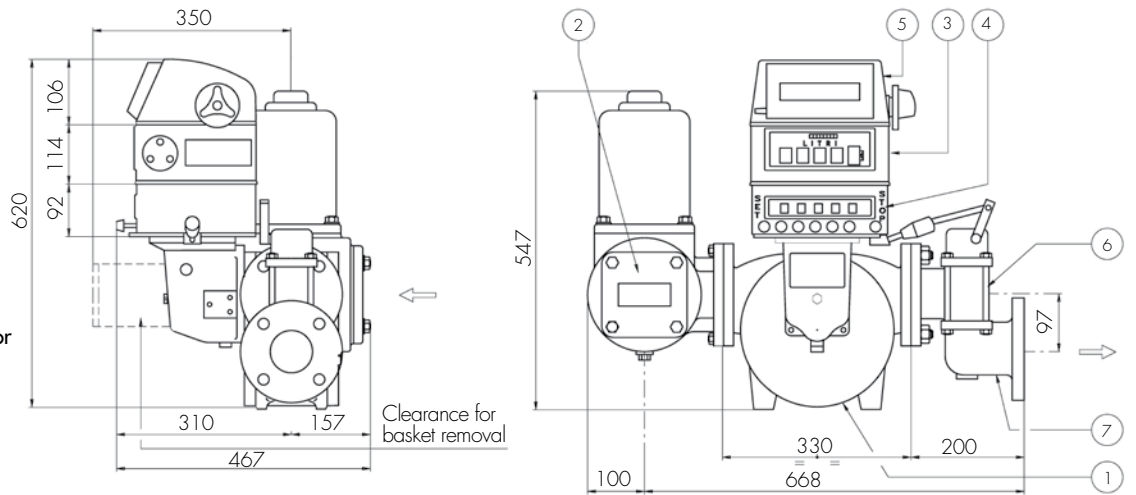

P.D. Meter weight with accessories

Type	CF	CFPVp	CFS	CFPVpS
SBM 75	38 Kg	44 Kg	43 Kg	49 Kg
SBM 150	62 Kg	75 Kg	67 Kg	80 Kg



Positive displacement meters series SBM 75 - SBM 150

Tank truck version

SBM 75 CEE

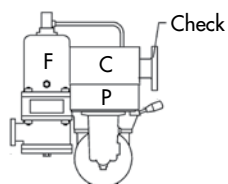

0) MOD: CFPVp + check

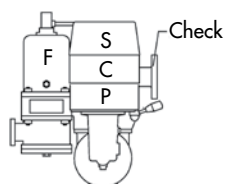

1) MOD: CFPVps + check

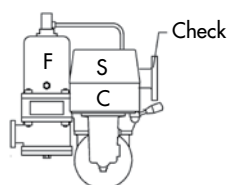

2) MOD: CFS + check

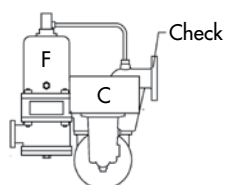

3) MOD: CF + check

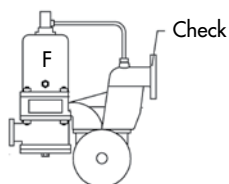

4) MOD: BARE SHAFT

C = "Counter" V/R 7887
F = Strainer-airseparator
P = Preset
Vp = Preset valve
S = Printer V/R
Check = Check valve

SBM 150 CEE

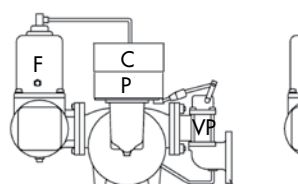

0) MOD: CFPVp + check

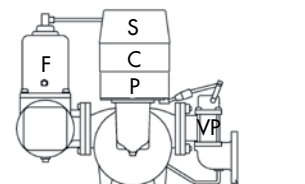

1) MOD: CFPVps + check

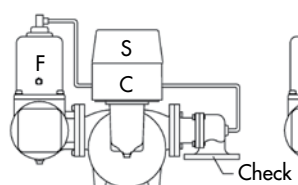

2) MOD: CFS + check

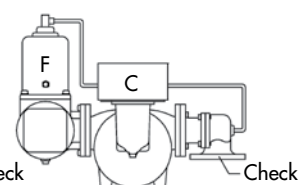

3) MOD: CF + check

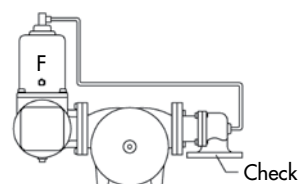

9) MOD: BARE SHAFT

