







CAD generated and maintained drawing. All printed and electronic copies outside of Griswold's engineering database are "Uncontrolled" and shall be used for reference only.

REV.	DESCRIPTION	BY	CHK.	APP.	DATE
A	RELEASED INTO PRODUCTION SEE ECN #G01031	-	-	-	-

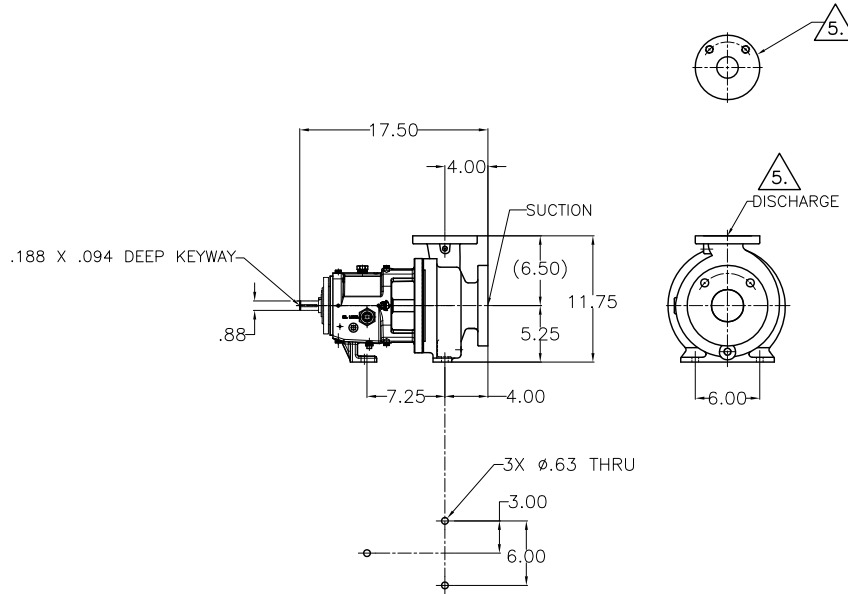
NOTES: UNLESS OTHERWISE SPECIFIED

- DIMENSIONS AND TOLERANCES PER ASME Y14.5M-1994.
- * INDICATES DIMENSIONS AND/OR FEATURES MODIFIED ON CURRENT REVISION LEVEL.
- DIMENSIONS REFLECT STANDARD MFG TOLERANCES.
-  WEIGHTS ARE APPROXIMATE BASED ON MANUFACTURER'S MATERIALS AND PUMP CONFIGURATION
-  THIS PUMP MAY HAVE TAPPED HOLES IN THE DISCHARGE FLANGE PER ASME B73.1.



FLANGE OPTION DIMENSIONS							
OPTION	NOMINAL PIPE SIZE	FLANGE DIAMETER	BOLT CIRCLE DIAMETER	NO. OF BOLTS	DIAMETER OF BOLTS	BOLT HOLE	FLANGE
✓	1" ASME 150# (SHOWN) (THD) 						DISCHARGE
	1.00	4.25	3.12	4	0.50	.500-13 UNC-2B	
✓	2" ASME 150# (SHOWN)						SUCTION
	2.00	6.00	4.75	4	0.63	0.75	
✓	1" ASME 300# (THD) 						DISCHARGE
	1.00	4.88	3.50	4	0.63	.625-11 UNC-2B	
✓	2" ASME 300#						SUCTION
	2.00	6.50	5.00	8	0.63	0.75	
✓	25 mm DIN PN16 (THD) 						DISCHARGE
	25 mm	115 mm	85 mm	4	12 mm	M12 x 1.75-6H	
✓	50 mm DIN PN16						SUCTION
	50 mm	165 mm	125 mm	4	16 mm	19 mm	

CERTIFIED FOR CONSTRUCTION

ONLY WHEN SIGNED

Signature _____
Date _____

Customer _____

Customer P.O. # _____

 PUMP WT.- 103 LBS

OPTION	AVAILABLE OPTIONS
✓	
PUMP MATERIAL	
	N6 DUCTILE IRON
	N6 DUCTILE IRON CASE / 91 SS IMPELLER
	91 STAINLESS STEEL
	20 HASTELLOY
	X4 CD4MCU SS
	OTHER:
FLANGE FACE	
	FLAT FACE
	RAISED FACE

DO NOT SCALE DRAWING	
UNLESS OTHERWISE SPECIFIED DIMENSIONS ARE IN INCHES TOLERANCES ARE:	
DECIMALS .XX	± -
.XXX	± -
ANGLES	± -
SCALE 1/8	SHEET 1 OF 1

		GRISWOLD PUMP COMPANY 22965 VAN BUREN STREET GRAND TERRACE, CA 92313-9697 PHONE: (909) 942-9222 / (925) 226-5255 WWW.GRISWOLDPUMP.COM	
TITLE 3 X 2 - 6 (AC) PEO, SM PF			
DRAWN BY R. Schwartz	DATE 1/17/17	ASSY. NO.	
CHECKED BY R. Beach	DATE 1/26/17	DRAWING NO.	
APPROVED BY B. Backman	DATE 1/26/17	LG0769	REV. A

THIS DOCUMENT AND ITS CONTENTS ARE PROPRIETARY TO GRISWOLD PUMP ANY REPRODUCTION, DISCLOSURE OR USE OF THIS DOCUMENT IS EXPRESSLY PROHIBITED EXCEPT AS OTHERWISE AGREED TO IN WRITING.