



960524	PARTS LIST
Page 1 of 8	502-C02
Section	502
Effective	Jul 2023
Replaces	Nov 2019

LB162B PARTS LIST

(See Instructions 502-C00 for Operation and Maintenance)

Serial # _____

ID# _____

Gasket Set and Special Tools		
Gasket Set	Buna-N & Aluminum	792599
Packing Installation Tool		790536
Spanner Wrench, 1/4" Adjustable		790316
Wrench for Valve Hold Down Screw		790535
Tool Kit		790199
Piston Tool		798003

Content Needed For Complete Parts List	
Cover Page	1
Crankcase	2
Oil Pump	3
Flywheel	4
Crosshead	5
Cylinder	6
Head	7

Notes:

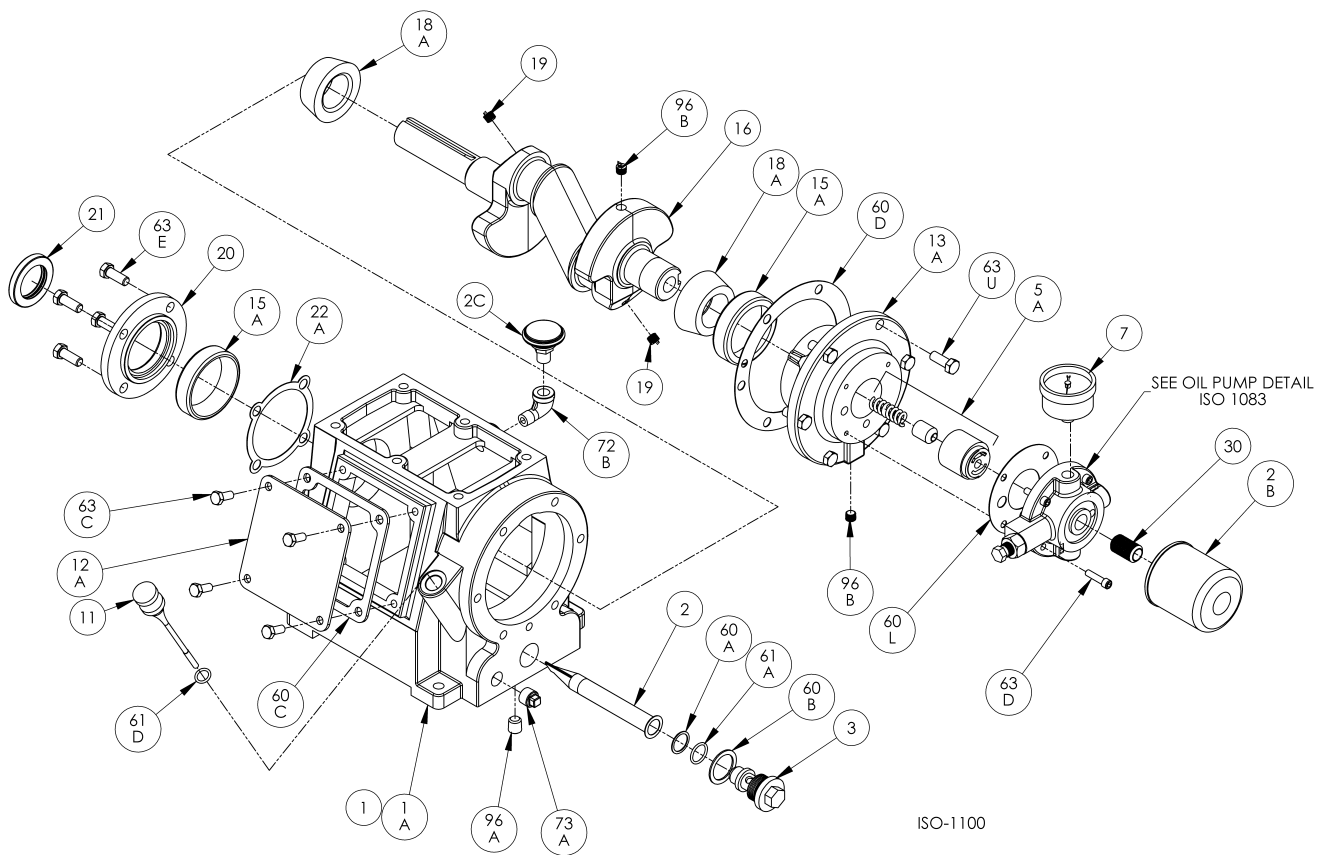

Crankcase Assembly: Models LB161B, LB162B

ISO1100

Ref	Description	Qty	Part No
1	Crankcase Assembly – with Oil Filter (std)	1	792100
	Crankcase Assembly – no Oil Filter		792103
	Crankcase Assembly - with Ext. Shaft		792155
	Crankcase Assy - Ext Shaft & Oil Filter		792171
1A	Crankcase	1	792102
2	Oil Intake Screen	1	792135
2B	Oil Filter	1	794726
2C	Breather Filter	1	792070
3	Oil Screen Plug	1	792145
5A	Oil Pump Kit	1	794760
7	Oil Pressure Gauge	1	790012
11	Oil Bayonet Assembly	1	792162
12A	Inspection Plate	1	792105
13A	Bearing Carrier	1	792104
15A	Bearing Cup	2	793126
16	Crankshaft Assembly (w\ 18A,19,96B)	1	792157
	Crankshaft Assembly-Ext (w\ 18A,19,96B)		792191
18A	Bearing Cone	2	793142
19	Orifice	2	792146

Ref	Description	Qty	Part No
20	Bearing Cover Plate	1	793106
21	Oil Seal	1	793143
22A	Bearing Adjustment Shim Kit	1	793133
30	Oil Filter Fitting	1	794725
60A	Gasket - Oil Screen *	1	792136
60B	Gasket - Oil Screen Plug *	1	792123
60C	Gasket - Inspection Plate *	1	792122
60D	Gasket - Bearing Carrier Assembly*	1	792124
60L	Gasket - Oil Pump Cover *	1	794721
61A	O-Ring - Oil Screen *	1	792175
61D	O-Ring - Oil Bayonet *	1	792174
63C	Capscrew - Hex Hd	4	793116
63D	Capscrew - Soc Hd	4	790559
63E	Capscrew - Hex Hd	4	792093
63U	Capscrew - Hex Hd	6	792093
72B	Elbow	1	790453
73A	Pipe Plug	1	792166
96A	Pipe Plug	1	790488
96B	Pipe Plug	2	790309

* Included in Gasket Sets

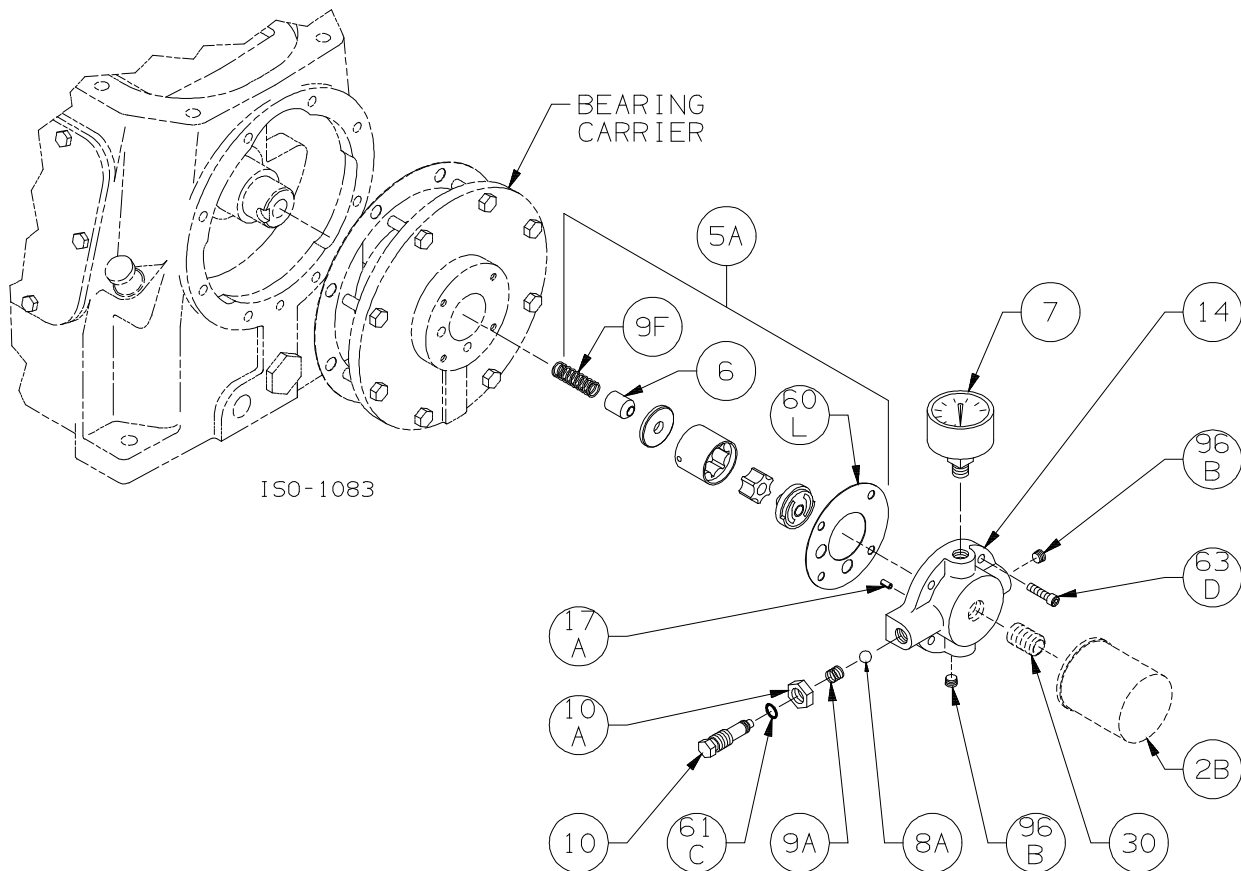

Oil Pump Detail:

Models LB081B, LB082B, LB161B, LB162B, LB361B, LB362D,
LB601B, LB602B, LB602C, LB942A, LB942B, LB943B

ISO1083

Ref	Description	Qty	Part No
2B	Oil Filter	1	794726
5A	Oil Pump Kit (with 6, 9F, 60L)		794760
6	Oil Pump Cone	1	794750
7	Oil Pressure Gauge	1	790012
8A	Oil Pressure Adj. Ball	1	792154
9A	Oil Pressure Adj. Spring	1	792153
9F	Oil Pump Spring	1	794751
10	Oil Pressure Adj. Screw	1	792148
10A	Locknut	1	792152

Ref	Description	Qty	Part No
	Oil Pump Cover Assembly - For Filter		794764
14	Oil Pump Cover Assembly (both include 17A, 96B)	1	794763
17A	Roll Pin	1	794753
30	Oil Filter Fitting	1	794725
60L	Gasket - Oil Pump Cover *	1	794721
61C	O-Ring - Adjusting Screw *	1	792168
63D	Capscrew - Socket Head	4	790559
96B	Pipe Plug	2	790309

* Included in Gasket Sets

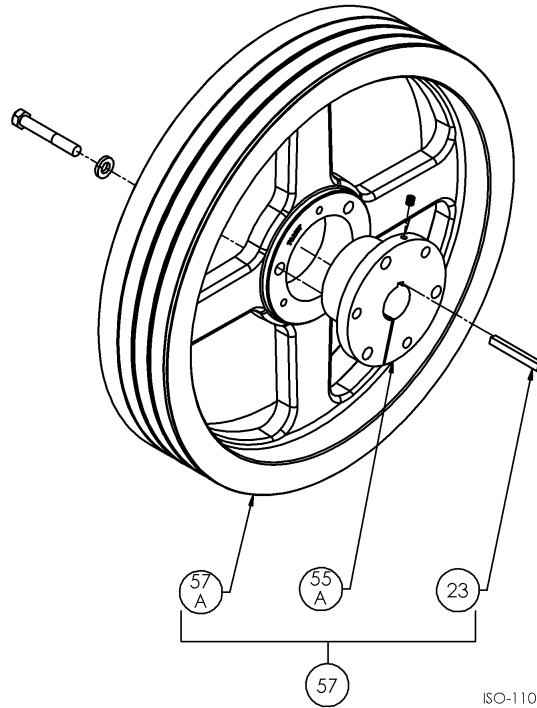
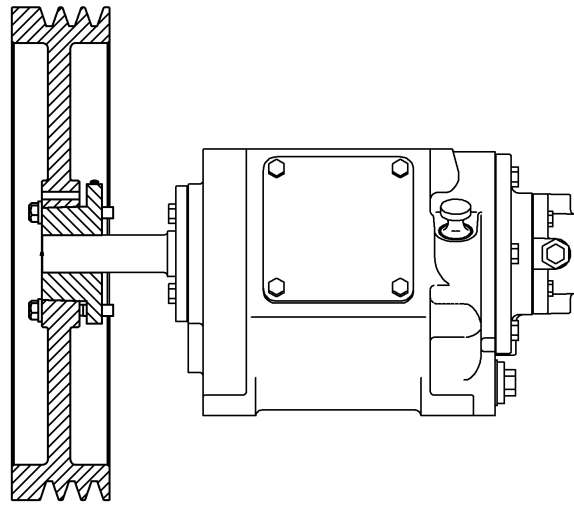

ISO-1106

Flywheel Assembly:

S1106

Models LB081B, LB082B, LB161B, LB162B

Models LB361B, LB362D

Ref	Description	Qty	Part No
23	Key	1	792167
55A	Hub (SF 1.25")	1	790563
57	Flywheel Assembly	1	792073
57A	Flywheel	1	792197

Ref	Description	Qty	Part No
23	Key	1	793167
55A	Hub	1	790143
57	Flywheel Assembly	1	793047
57A	Flywheel	1	792197

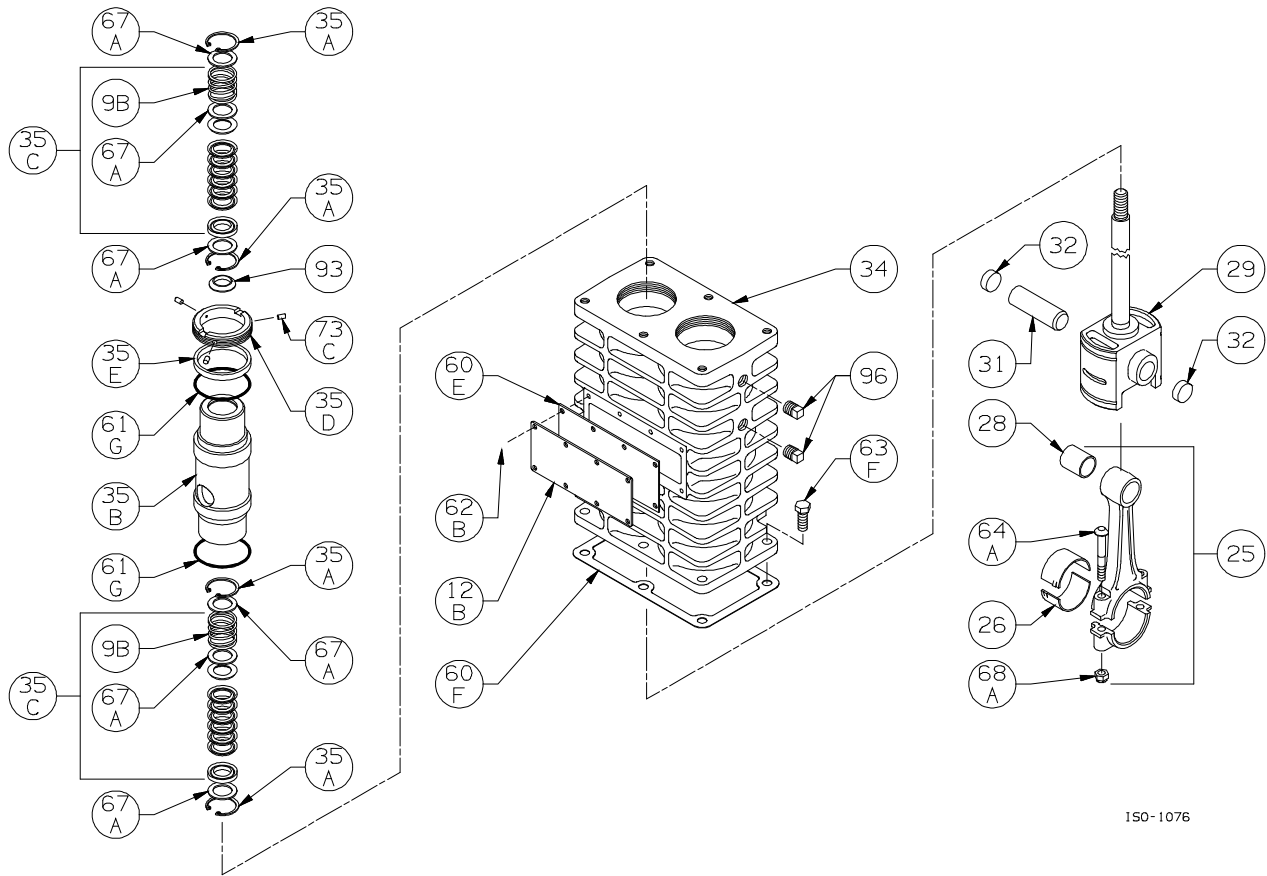

150-1076

Crosshead Assembly: LB162B

ISO1076

Ref	Description	Qty	Part No
9B	Packing Spring	4	792077
12B	Inspection Plate	1	792017
25	Connecting Rod Assembly	2	792009
26	Connecting Rod Bearing	2	792012
28	Wrist Pin Bushing **	2	792013
29	Crosshead Assembly	2	792429
31	Wrist Pin	2	792014
32	Wrist Pin Plug	4	792178
34	Crosshead Guide	1	792455
35A	Retainer Ring	8	793404
35B	Packing Box	2	792502
35C	Packing Set	4	793499
35D	Hold-down Ring	2	793220

Ref	Description	Qty	Part No
35E	Spacer Ring	2	793402
60E	Gasket - Inspection Plate *	1	792092
60F	Gasket - Crankcase *	1	792121
61G	O-Ring (Buna-N) Std *	4	792125
62B	Machine Screw - Inspection Plate	8	793096
63F	Capscrew - Hex Hd	6	792093
64A	Connecting Rod Bolt	4	792006
67A	Washer - Packing Box	12	792087
68A	Connecting Rod Bolt Nut	4	792005
73C	Lock Plug *	6	792030
93	Oil Deflector Ring	2	793478
96	Pipe Plug	4	793498

*Included in Gasket Sets

** Must be honed after installing

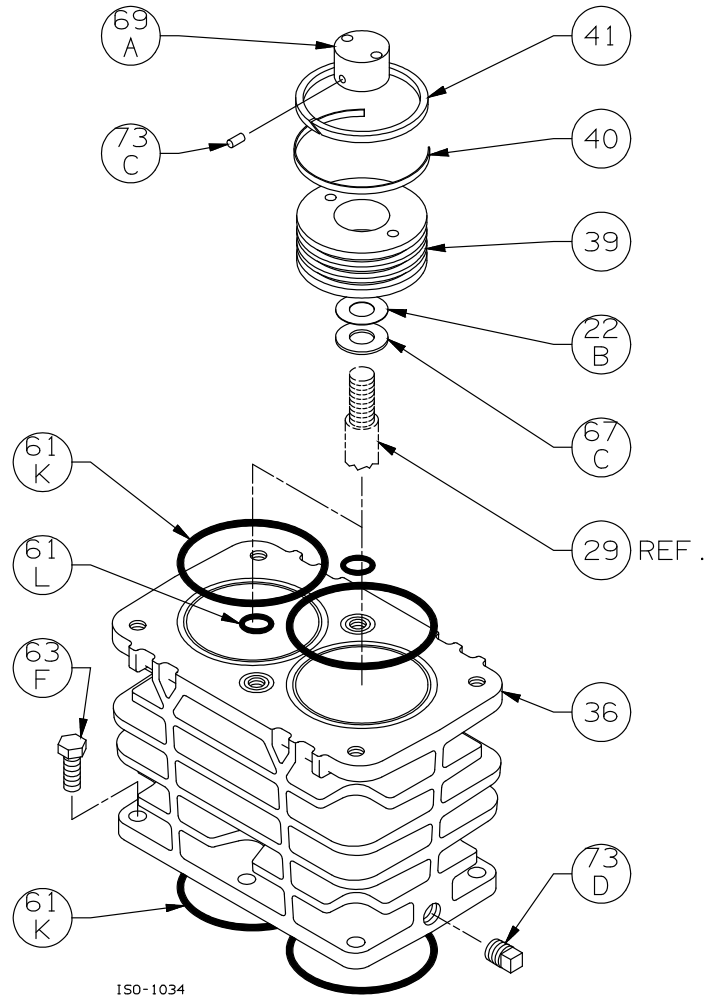

ISO-1034

Cylinder Assembly:
Models LB161, LB161B, LB162B

ISO1034

Ref	Description	Qty	Part No
22B	Piston Shim - 0.015	AR	792034
	Piston Shim - 0.007		792050
36	Cylinder	1	792101
39	Piston	2	792031
40	Expander	6	792022
41	Piston Ring	6	792018
61K	O-Ring *	4	792112
61L	O-Ring *	2	792114
63F	Capscrew - Hex Hd	6	792093
67C	Thrust Washer	2	792033
69A	Piston Nut	2	793022
73C	Lock Plug *	4	793028
73D	Pipe Plug	1	793498

* Included in Gasket Sets

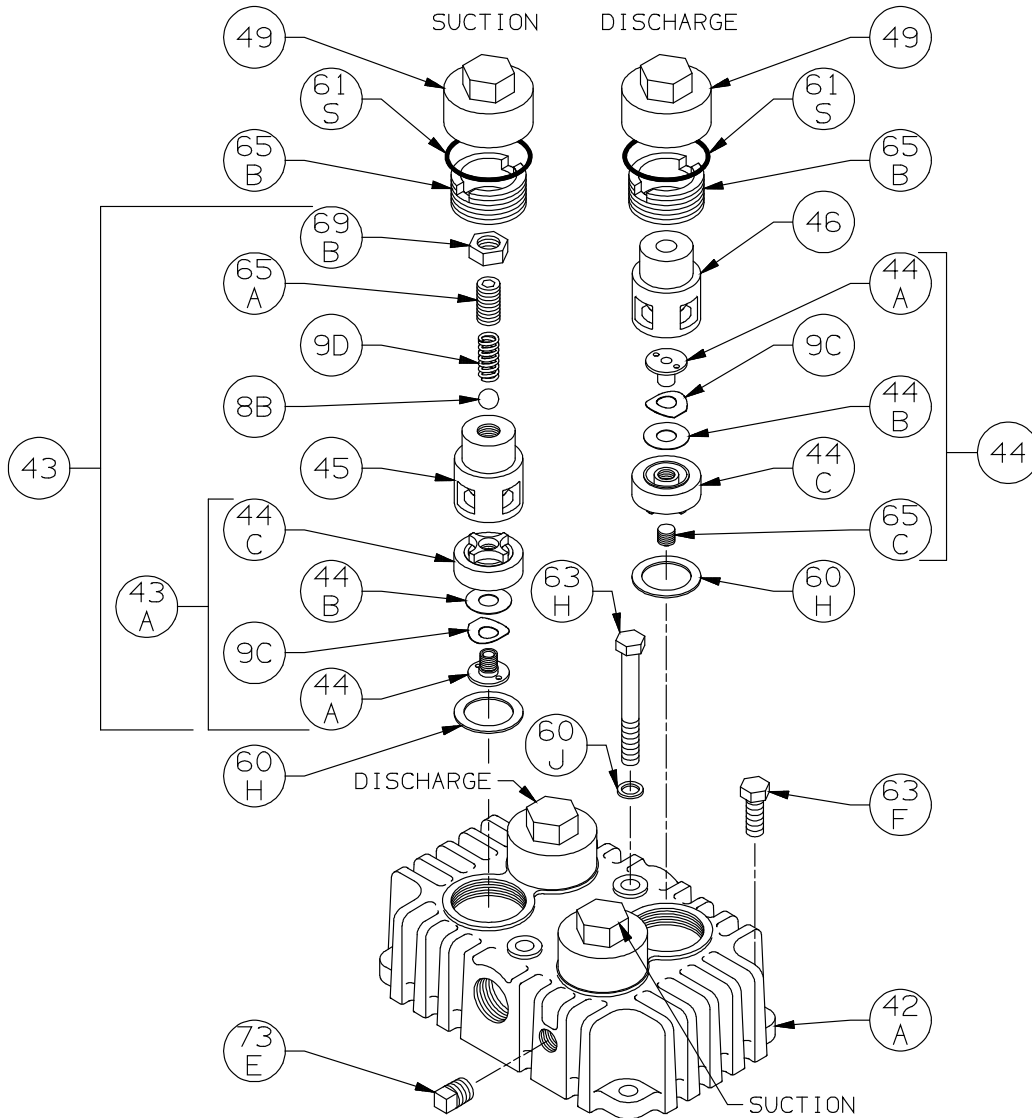

ISO-1033

Head Assembly: Models LB161, LB161B, LB162, LB162B

ISO1033

Ref	Description	Qty	Part No
8B	Liquid Relief Valve Ball	2	792042
9C	Valve Spring	4	792038
9D	Liquid Relief Valve Spring	2	792045
42A	Head	1	792111
43	Suction Valve Assembly	2	792269
43A	Valve Sub-Assembly	0	792259
44	Discharge Valve Assembly	2	792279
44A	Valve Bumper	4	792235
44B	Valve Disc	4	792037
44C	Valve Body	4	792236
45	Liquid Relief Valve Body	2	792046
46	Cage	2	792051

Ref	Description	Qty	Part No
49	Valve Cap	4	792003
60H	Gasket - Valve *	4	792107
60J	Gasket - Center Head Bolt *	2	792113
61S	O-Ring *	4	792306
63F	Capscrew - Hex Hd	4	792093
63H	Capscrew - Hex Hd	2	792095
65A	Liquid Relief Valve Screw	2	792043
65B	Valve Holddown Screw	4	792002
65C	Screw	2	792234
69B	Nut	2	792044
73E	Pipe Plug	2	793498

* Included in Gasket Sets

Suggested Spare Parts for LB162B Compressors:

Part #	Description	Qty./ Unit	Comm. Qty.	Spare Qty.
792599	Gasket Set - Buna-N, Aluminum	1	1	1
792259	Suction Valve Sub-Assembly	2		2
792279	Discharge Valve	2		2
792018	Piston Ring	6	6	6
792022	Piston Ring Expander	6	6	6
793499	Packing Set	4	4	4
794726	Oil Filter	1		6
792014	Wrist Pin	2		2
792013	Wrist Pin Bushing	2	2	2
792012	Conrod Bearing	2	2	2
The following parts would normally be required only for major compressor overhaul.				
793142	Bearing Cone	2		2
793126	Bearing Cup	2		2
792429	Crosshead Assembly	2		1
792009	Conrod Assembly	2		1
794760	Oil Pump Repair Kit	1		
792157	Crankshaft Assembly	1		
792191	Extended Crankshaft Assembly *			
793133	Bearing Adjustment Shim Kit	1		
792101	Cylinder	1		

* Optional Equipment on New Compressors