

IOM

INSTALLATION OPERATION
& MAINTENANCE

A075

PLASTIC 3/4 INCH

AIR-OPERATED DOUBLE-DIAPHRAGM PUMP



CE

PSG
a **DOVER** company

 **ALL-FLO**

TABLE OF CONTENTS

SECTION 1	WARNINGS, DANGERS AND CAUTIONS	3
SECTION 2	MODEL DESIGNATION MATRIX	4
SECTION 3	PRINCIPLES OF OPERATION	5
SECTION 4	DIMENSIONAL DRAWINGS	6
SECTION 5	PERFORMANCE CURVES	
	RUBBER, TPE AND PTFE DIAPHRAGMS.....	7
SECTION 6	INSTALLATION, TROUBLESHOOTING AND MAINTENANCE	
	INSTALLATION	8-9
	TRUBLESHOOTING	10
	OPERATION	11
	MAINTENANCE	11
SECTION 7	REPAIR AND ASSEMBLY	
	PUMP WET END REMOVAL.....	12-13
	AIR VALVE REMOVAL	14-15
	PILOT VALVE REMOVAL.....	16-17
	TORQUE SPECIFICATIONS.....	17
SECTION 8	EXPLODED VIEWS AND PARTS LISTS	18-20
SECTION 9	ELASTOMERS AND REPAIR KITS	21
SECTION 10	WARRANTY AND REGISTRATION	22

CAUTIONS — READ FIRST!

READ THESE WARNINGS AND SAFETY PRECAUTIONS PRIOR TO INSTALLATION OR OPERATION. FAILURE TO COMPLY WITH THESE INSTRUCTIONS COULD RESULT IN PERSONAL INJURY AND OR PROPERTY DAMAGE. RETAIN THESE INSTRUCTIONS FOR FUTURE REFERENCE.

CAUTION Always wear safety glasses when operating a pump to avoid eye injury. If diaphragm rupture occurs, material being pumped may be forced out of the air exhaust.

CAUTION Do not connect a compressed air source to the exhaust port of the pump.

CAUTION Do not lubricate air supply.

CAUTION Do not exceed 120 psig (8.3 bar) air-inlet pressure.

CAUTION Do not exceed 10 psig (0.7 bar) or 23 ft-H₂O suction pressure.

CAUTION The temperature of the process fluid and air input must be no more than the maximum temperature allowed for the appropriate non-metallic material. See the list of temperatures below for each material's maximum recommended temperature:

Buna-N (Nitrile):	10°F to 180°F (-12°C to 82°C)
Geolast®:	10°F to 180°F (-12°C to 82°C)
Bunast™:	-40°F to 266°F (-40°C to 130°C)
EPDM:	-40°F to 280°F (-40°C to 138°C)
FKM:	-40°F to 350°F (-40°C to 177°C)
Hytrel®:	-20°F to 220°F (-29°C to 104°C)
Nylon:	0°F to 200°F (-18°C to 93°C)
PTFE:	40°F to 220°F (4°C to 104°C)
Polyethylene:	32°F to 158°F (0°C to 70°C)
Polypropylene:	32°F to 180°F (0°C to 82°C)
Polyurethane:	10°F to 150°F (-12°C to 66°C)
PVDF:	0°F to 250°F (-18°C to 121°C)
Santoprene®:	-40°F to 225°F (-40°C to 107°C)
Urethane:	-65°F to 220°F (-54°C to 104°C)

Temperature limits are solely based upon mechanical stress and certain chemicals will reduce the maximum operating temperature. The allowable temperature range for the process fluid is determined by the materials in contact with the fluid being pumped. Consult a chemical resistance guide for chemical compatibility and a more precise safe temperature limit. Always use minimum air pressure when pumping at elevated temperatures.

CAUTION It is the end user's responsibility to maintain the process fluid's temperature during use.

CAUTION Ensure all wetted components are chemically compatible with the process fluid and the cleaning fluid.

WARNING = Hazards or unsafe practices which could result in severe personal injury, death or substantial property damage

CAUTION = Hazards or unsafe practices which could result in minor personal injury, product or property damage.

WARNING Prior to servicing the pump, ensure that the air and fluid lines are closed and disconnected. While wearing personal protective equipment, flush, drain and process liquid from the pump in a safe manner.

WARNING Maintenance must not be performed when a hazardous atmosphere is present.

CAUTION The equipment must be inspected for visible damage prior to use.

CAUTION Ensure pump is thoroughly cleaned and flushed prior to installation into a process line.

CAUTION Blow out all compressed air lines in order to remove any debris, prior to pump installation. Ensure that the muffler is properly installed prior to pump operation.

CAUTION Ensure air exhaust is piped to atmosphere prior to a submerged installation.

CAUTION Ensure all hardware is set to correct torque values prior to operation.

WARNING Pump, valves and all containers must be properly grounded prior to handling flammable fluids and/or whenever static electricity is a hazard.

WARNING This product can expose you to chemicals including Nickel, Chromium, Cadmium, or Cobalt, which are known to the State of California to cause cancer and/or birth defects or other reproductive harm. For more information, go to www.P65Warnings.ca.gov.

MODEL DESIGNATION MATRIX-BOLTED PLASTIC

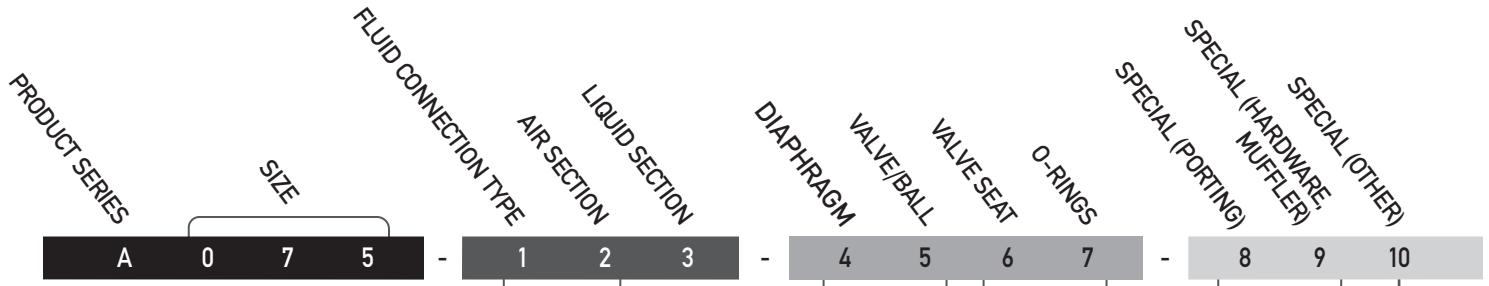

- 1 FLUID CONNECTION TYPE**
N = NPT
B = BSPT
- 2 AIR SECTION**
P = Polypropylene Intermediate-Pneumatic Shift
- 3 LIQUID SECTION**
K = PVDF
P = Polypropylene

- 4 DIAPHRAGMS**
G = Bunalast™
S = Santoprene®
T = PTFE with Santoprene® Backup
V = FKM

- 5 VALVE/BALL**
G = Bunalast™
S = Santoprene®
T = PTFE
V = FKM
3 = Stainless Steel

- 6 VALVE SEAT**
P = Polypropylene
K = PVDF
3 = Stainless Steel
- 7 O-RINGS**
E = EPDM
N = Buna-N
T = PTFE
V = FKM

- 8 PORTING**
S = Default (Suction Right / Discharge Right)
T = Suction Right / Discharge Left
X = Suction Left / Discharge Right
Y = Suction Left / Discharge Left
A = Suction Center Front / Discharge Center Front
B = Suction Center Front / Discharge Center Rear
C = Suction Center Front / Discharge Top
D = Suction Center Front / Discharge Right
E = Suction Center Front / Discharge Left
F = Suction Center Rear / Discharge Center Front
G = Suction Center Rear / Discharge Center Rear
H = Suction Center Rear / Discharge Top
I = Suction Center Rear / Discharge Right
J = Suction Center Rear / Discharge Left
K = Suction Bottom / Discharge Center Front
L = Suction Bottom / Discharge Center Rear
M = Suction Bottom / Discharge Top
N = Suction Bottom / Discharge Right
O = Suction Bottom / Discharge Left
P = Suction Right / Discharge Center Front
Q = Suction Right / Discharge Center Rear
R = Suction Right / Discharge Top
U = Suction Left / Discharge Center Front
V = Suction Left / Discharge Center Rear
W = Suction Left / Discharge Top
4 = All Ports Open (Standard ports will be left un-plugged)

- 9 SPECIAL OPTION (HARDWARE, MUFFLER, LUG)**
7 = Stainless Steel Hardware, Standard Muffler
8 = Stainless Steel Hardware, Premium Muffler
B = PTFE Coated Stainless Steel Hardware, Standard Muffler
C = PTFE Coated Stainless Steel Hardware, Premium Muffler

- 10 SPECIAL OPTION (OTHER)**
0 = Standard
1 = Cycle Counter Valve
2 = Solenoid Adaptor Valve 110/50 Volt AC, 120/60 Volt AC, DIN 43650B Connector
3 = Solenoid Adaptor Valve 110/50 Volt AC, 120/60 Volt AC Explosion Proof
4 = Solenoid Adaptor Valve 220/50 Volt AC, 240/60 Volt AC, 12 Volt DC, DIN 43650B Connector
5 = Solenoid Adaptor Valve 220/50 Volt AC, 240/60 Volt AC, 12 Volt DC Explosion Proof
6 = Solenoid Adaptor Valve 220/50 Volt AC, 240/60 Volt AC, 125 Volt DC, DIN 43650B Connector
7 = Solenoid Adaptor Valve 220/50 Volt AC, 240/60 Volt AC, 125 Volt DC Explosion Proof
8 = Solenoid Adaptor Valve 24 Volt DC, DIN 43650B Connector
9 = Solenoid Adaptor Valve 24 Volt DC, Explosion Proof
A = Grease Free (No lubrication assembly)

WET END REPAIR KIT

Wet end kits are available and consist of diaphragms, (back-up diaphragms if required), balls, seats and seat O-Rings. See matrix below.

AIR END REPAIR KIT

Air end repair kit contains pilot sleeve assembly and main air valve.

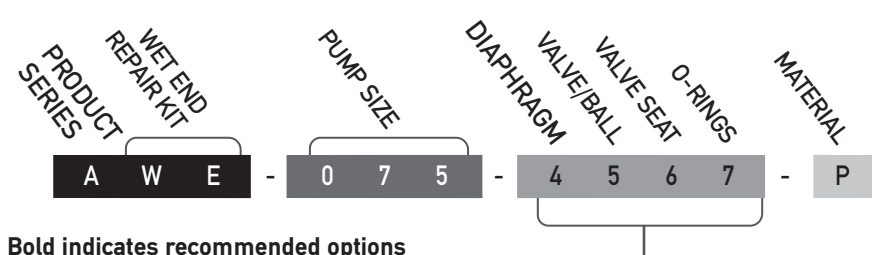

Bold indicates recommended options



PRINCIPLES OF OPERATION

HOW AN AIR OPERATED DOUBLE DIAPHRAGM PUMP WORKS

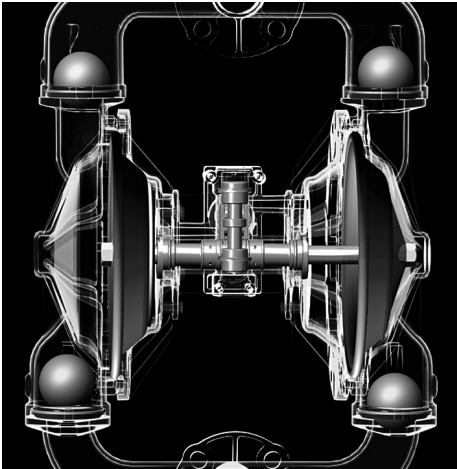

The air-valve directs pressurized air behind the diaphragm on the right, causing the diaphragm on the right to move outward (to the right).

Since both the right diaphragm and the left diaphragm are connected via a diaphragm rod, when the right diaphragm moves to the right, the left diaphragm (through the action of the diaphragm rod) moves to the right also.

When the diaphragm on the left side is moving to the right, it is referred to as suction stroke. When the left diaphragm is in its suction stroke, the left suction ball moves upward (opens) and the left discharge ball moves downward (closes). This action creates suction and draws liquid into the left side chamber.

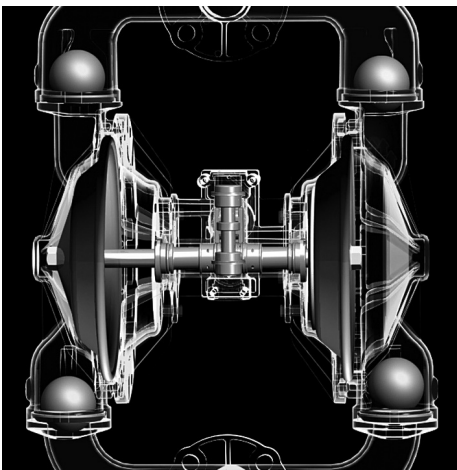

The air-valve directs pressurized air behind the left diaphragm, causing the left diaphragm to move outward (to the left).

Since both the left diaphragm and the right diaphragm are connected via a diaphragm rod, when the left diaphragm moves to the left, the right diaphragm (through the action of the diaphragm rod) moves to the left also.

When the diaphragm on the left side moves outward, the left discharge ball moves upward (opens) and the left suction ball moves downward (closes). This causes the liquid to leave the left side liquid outlet of the pump.

Simultaneously, the right diaphragm moves inward (to the left), which causes the right suction ball to open and the right discharge to close, which in turn causes suction, drawing liquid into the right chamber.

The process of alternating right suction / left discharge (and vice-versa) continues as long as compressed air is supplied to the pump.

3/4" PUMP DIMENSIONS

BOLTED PLASTIC

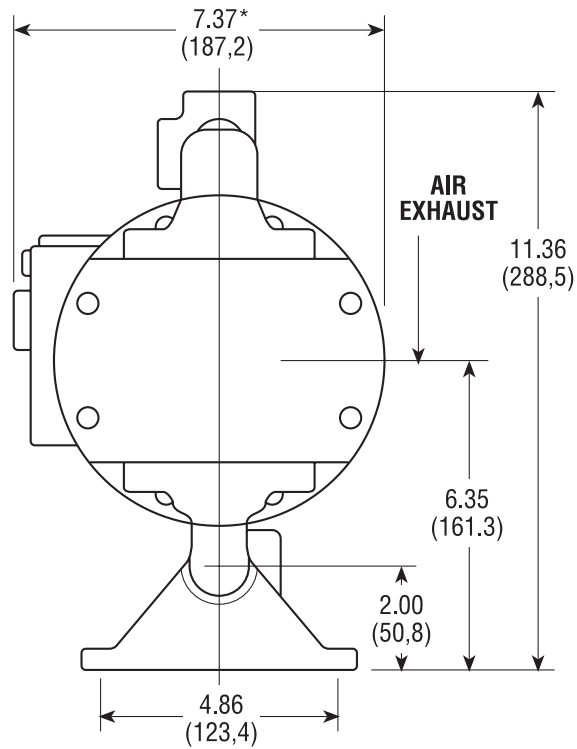
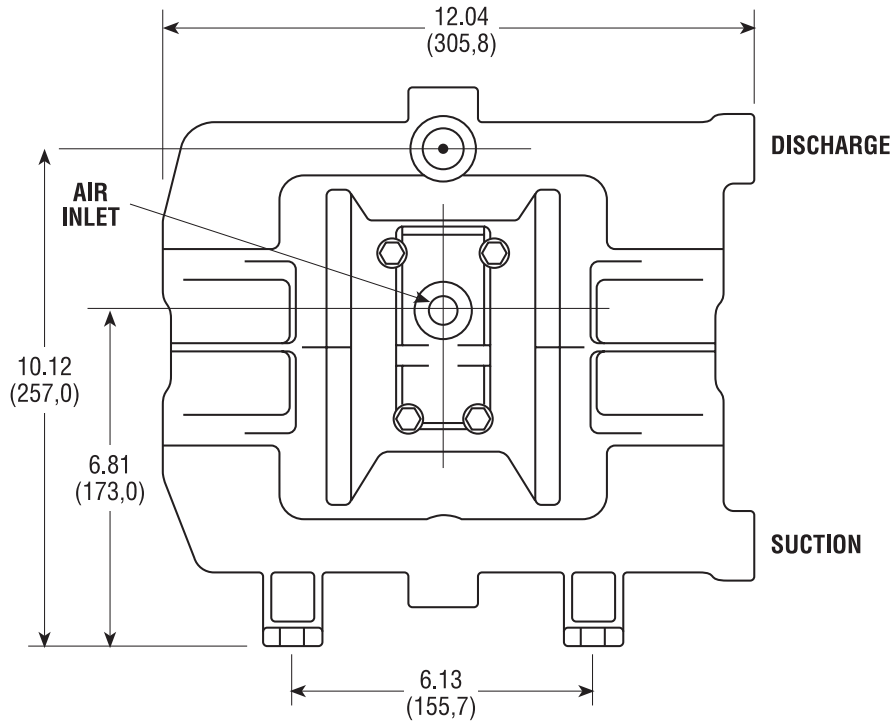

PERFORMANCE CURVES

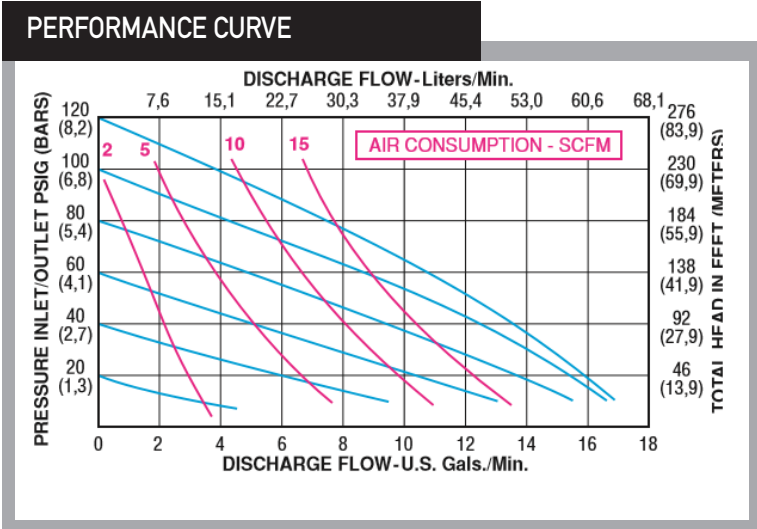

Performance Specifications

Max. Flow:	17 gpm (64.4 lpm)
Max. Air Pressure:	120 psi (8.3 bar)
Max. Solids:	1/8" (3.2 mm)
Max. Suction Lift Dry:	15 ft-H ₂ O (4.6 m-H ₂ O)
Max. Suction Lift Dry w/PTFE:	10 ft-H ₂ O (3.0 m-H ₂ O)
Max. Suction Lift Wet:	26 ft-H ₂ O (7.9 m-H ₂ O)
Weight Polypropylene:	9 lbs (4.1 kg)
Weight PVDF & Conductive Nylon	12 lbs (5.4 kg)
Air Inlet:	1/4" FNPT
Liquid Inlet FNPT/FBSPT:	3/4"
Liquid Outlet FNPT/FBSPT:	3/4"
Height:	11.4" (289 mm)
Width:	12.0" (306 mm)
Depth:	7.4" (187 mm)

*Flow rates indicated on the chart(s) shown were determined by pumping water at flooded suction. For optimum life and performance, pumps should be specified so that daily operation parameters will fall in the center of the pump performance curve.

INSTALLATION, TROUBLESHOOTING AND MAINTENANCE

INSTALLATION PIPING

Whenever possible ensure the pump is installed using the shortest possible pipe lengths with the minimum amount of pipe fittings. Ensure all piping is supported independent of the pump.

Suction and discharge piping should not be smaller than the connection size of the pump. When pumping liquids of high viscosity, larger piping may be used, in order to reduce frictional pipe loss.

Employ flexible hoses in order to eliminate the vibration caused by the pump. Mounting feet can also be used to reduce vibration effects.

All hoses should be reinforced, non-collapsible and be capable of high vacuum service. Ensure that all piping and hoses are chemically compatible with the process and cleaning fluid.

For processes where pulsation effects should be reduced, employ a pulsation dampener on the discharge side of the pump.

For self-priming applications, ensure all connections are airtight and the application is within the pumps dry-lift capability. Refer to product specifications for further details.

For flooded suction applications, install a gate valve on the suction piping in order to facilitate service.

For unattended flooded suction operation, it is recommended to pipe the exhaust air above the liquid source. In the event of a diaphragm failure this will reduce or eliminate the possibility of liquid discharging through the exhaust onto the ground.

LOCATION

Ensure that the pump is installed in an accessible location, in order to facilitate future service and maintenance.

AIR

Ensure that the air supply is sufficient for the volume of air required by the pump. Refer to product specifications for further details. For reliable operation, install a 5 micron air filter, air-valve and pressure regulator. Do not exceed the pumps maximum operating pressure of 120 psig.

REMOTE OPERATION

Utilize a three way solenoid valve for remote operation. This ensures that air between the solenoid and the pump is allowed to “bleed off,” ensuring reliable operation. Liquid transfer volume is estimated by multiplying displacement per stroke times the number of strokes per minute

NOISE

Correct installation of the muffler reduces sound levels. Refer to product specifications for further details.

SUBMERGED OPERATION

For submersible operation, pipe the air exhaust to atmosphere

GROUNDING THE PUMP

Loosen grounding screw and install a grounding wire. Tighten grounding screw. Wire size should be a 12 gauge wire or larger. Connect the other end of the wire to a true earth ground. Equipment must be grounded to achieve ATEX rating and it is recommended to configure the pump with a grounding lug option.



SUGGESTED INSTALLATION

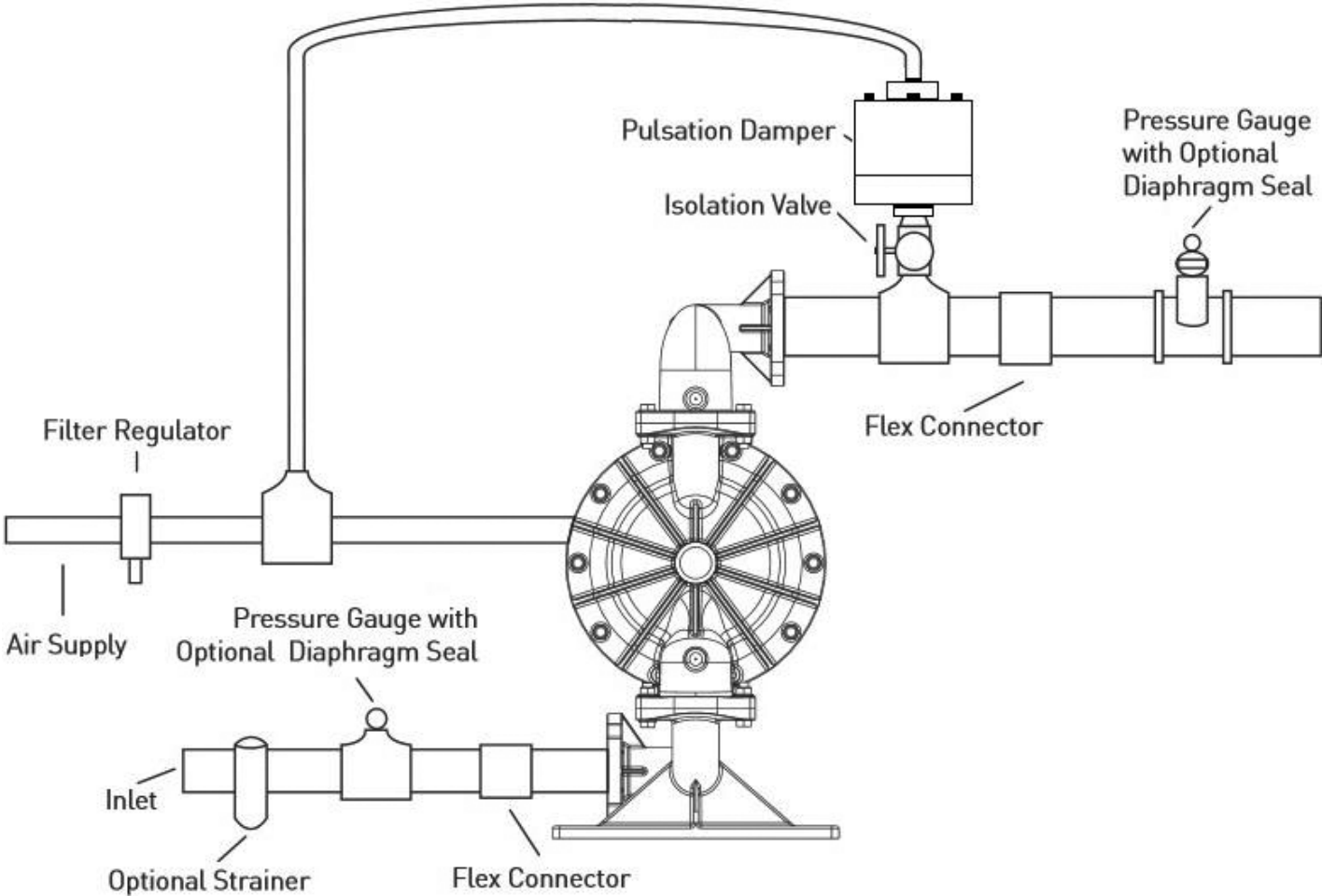

This illustration is a generic representation of an air operated double-diaphragm pump.

TROUBLESHOOTING

PROBLEM

EFFECT/SOLUTION

Pump Will Not Cycle

- Discharge line closed or plugged
- Discharge filter blocked
- Check valve stuck
- Air filter blocked
- Air supply valve closed
- Air supply hooked up to muffler side of pump
- Compressor not producing air or turned off
- Muffler iced or blinded
- Diaphragm ruptured
- Plant air supply line ruptured
- Air valve wear/debris
- Pilot sleeve wear/debris
- Diaphragm rod broken
- Diaphragm plate loose

Pumped Fluid Coming Out of Muffler

- Diaphragm ruptured
- Diaphragm plate loose
- Inlet liquid pressure excessive (above 10 psig)

Pump Cycles but no Flow

- Inlet strainer clogged
- Suction valve closed
- Suction line plugged
- No liquid in the suction tank
- Suction lift excessive
- Debris stuck in valves
- Excessive wear of check valves
- Air leak on suction side with suction lift

Pump Cycles with Closed Discharge Valve

- Debris stuck in check valve
- Excessive wear of check valves

Pump Running Slowly/Not Steady

- Air compressor undersized
- Leak in air supply
- Air-line, filter regulator or needle valve undersized
- Muffler partially iced or blinded
- Air valve gasket leak or misalignment
- Air valve wear/debris
- Pilot sleeve wear/debris
- Liquid fluid filter blocked
- Pump may be cavitating, reduce speed of operation
- Suction strainer clogged

Pump Will Not Prime

- Air leak in suction pipe
- Air leak in pump manifold connections
- Suction strainer and lines clogged
- Excessive lift conditions
- Check valve wear
- Debris in check valve

OPERATION

The Air-Operated Double Diaphragm Pump requires a minimum of 20 psig of air to operate, with some variation according to diaphragm material. Increasing the air pressure results in a more rapid cycling of the pump and thus a higher liquid flow rate. In order to not exceed 120 psig of inlet air pressure, and for accurate control of the pump, it is suggested to use a pressure regulator on the air inlet.

An alternate means of controlling the flow-rate of the pump is to use an inlet air valve and partially open or close accordingly. When the air valve is completely in the closed position, the pump will cease to operate.

A third method of controlling the flow rate of the pump is to use a liquid discharge valve. Closing the liquid discharge valve will cause a decrease in the flow rate since the pump will operate against a higher discharge pressure.

Solenoid control of the inlet air may also be used in order to facilitate remote operation. A three way solenoid valve is recommended, in order to allow the air to “bleed off” between the solenoid and the pump.

Do not use valves for flow control on the suction side of the pump. (Closing or partially closing a liquid suction valve restrict the suction line and may cause damage to the diaphragms.) Suction strainers may be employed to reduce or eliminate larger solids, but routine maintenance is necessary in order to prevent a restriction on the suction.

MAINTENANCE

Due to the unique nature of each application, periodic inspection of the pump is the best method to determine a proper maintenance schedule. A record should be kept of all repairs made to an installed pump. This will serve as the best predictor of future maintenance.

Typical maintenance involves replacing of “wear-parts” such as the diaphragms, balls, valve seats and O-rings. Proper maintenance can ensure trouble-free operation of the pump. Refer to repair and assembly instructions for further details.

 **WARNING** Maintenance must not be performed when a hazardous atmosphere is present.

MAINTENANCE SCHEDULE

WEEKLY (OR DAILY)

Make a visual check of the pump. If pumped fluid is leaking out of the pump, pipe fittings or muffler turn off pump and schedule maintenance.

EVERY THREE MONTHS

Inspect fasteners and tighten any loose fasteners to recommended torque settings.

Schedule pump service based on pump’s service history.

REPAIR AND ASSEMBLY

PUMP WET END REMOVAL

TOOLS NEEDED

- 1) One Wrench, $\frac{7}{16}$ Inch
- 2) Two Wrenches, $\frac{1}{2}$ Inch
- 3) Two Wrenches, $\frac{7}{8}$ Inch

⚠ WARNING Prior to servicing the pump, ensure that the air and fluid lines are closed and disconnected. While wearing personal protective equipment, flush, drain and process liquid from the pump in a safe manner.

⚠ WARNING Maintenance must not be performed when a hazardous atmosphere is present.



STEP 1

Using the 1/2 inch wrenches remove four "Hex-Head Cap Screws" and four "Hex Flange Nuts" from the "Discharge Manifold".

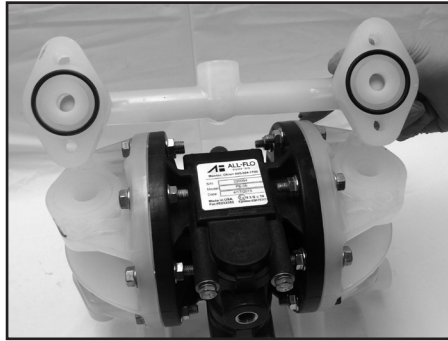

STEP 2

Remove the "Discharge Manifold".

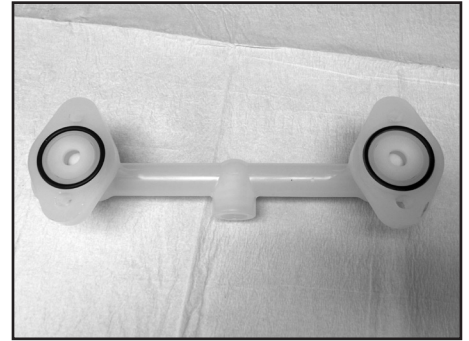

STEP 3

Remove the "O-Ring", "Valve Seat" and "Ball" from the "Discharge Manifold".

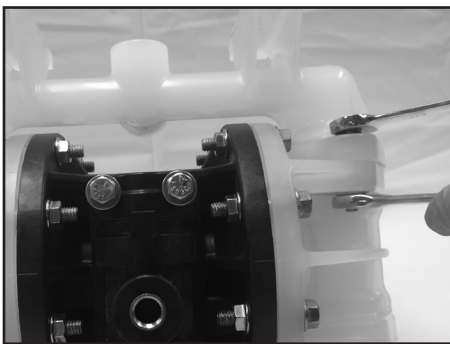

STEP 4

Using the 1/2 inch wrenches remove four "Hex-Head Cap Screws" and four "Hex Flange Nuts" from the "Suction Manifold".

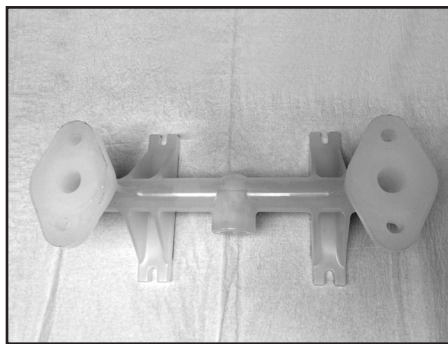

STEP 5

Remove the "Suction Manifold".

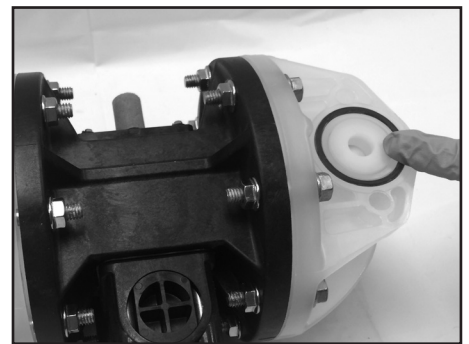

STEP 6

Remove the "O-Ring", "Valve Seat" and "Ball" from the "Outer Chambers".



STEP 7

In order to remove both “Outer Chambers”, using two ½ inch wrenches, remove eight “Hex Head Cap Screws” and eight “Hex Flange Nuts” from each side.

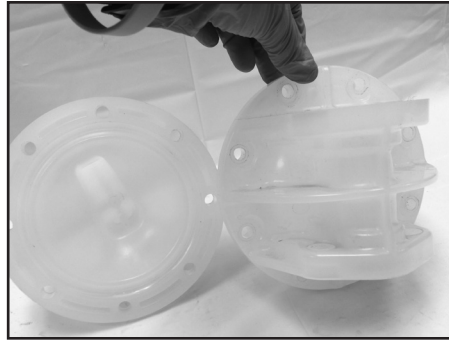

STEP 8

Remove both “Outer Chambers” from the “Intermediate”.

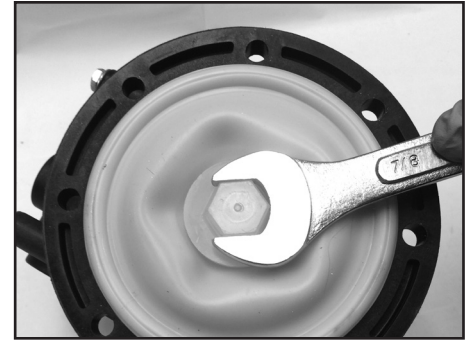

STEP 9

Using two 7/8 Inch wrenches, remove “Outer Diaphragm Plate”, “Diaphragm”, “Inner Diaphragm Plate” and “Flat Washer” from one side of the pump.

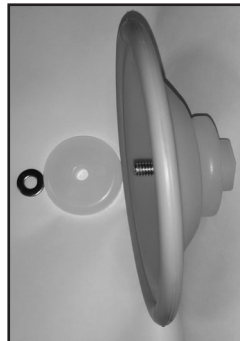
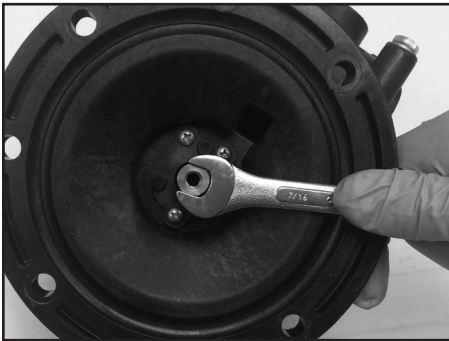

STEP 10

Placing the 7/8 inch wrench on the remaining “Outer Diaphragm Plate” and the 7/16 inch wrench on the “Diaphragm Rod Assembly”, remove the remaining “Outer Diaphragm Plate”, “Diaphragm”, “Inner Diaphragm Plate” and “Flat Washer” from the other side of the pump.

PUMP WET END ASSEMBLY

To assemble the wet end of the pump, reverse the order of disassembly. Ensure all hardware is fastened in accordance with torque specifications (see page 17). Inverting one of the diaphragms during reassembly will facilitate ease of assembly.

Note: When using pumps built with PTFE O-Rings, always replace with new PTFE O-Rings, since the original O-Rings may not reseal the pump.

REPAIR AND ASSEMBLY

AIR VALVE REMOVAL

TOOLS NEEDED

- 1) One Wrench, $\frac{7}{16}$ Inch
- 2) One Pick, General Purpose
- 3) One Pair of Pliers

⚠️ WARNING Prior to servicing the pump, ensure that the air and fluid lines are closed and disconnected. While wearing personal protective equipment, flush, drain and process liquid from the pump in a safe manner.

⚠️ WARNING Maintenance must not be performed when a hazardous atmosphere is present.

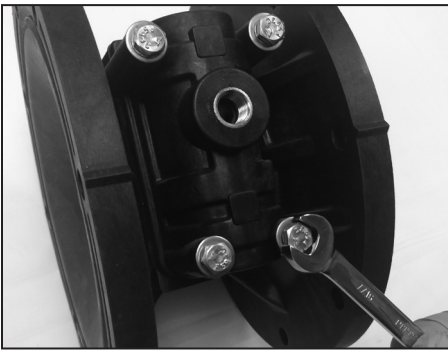

STEP 1

Using the $\frac{7}{16}$ inch wrench, remove four "Hex Head Cap Screws", four "Lock Washers", four "Flat Washers" and four "Hex Nuts" (rear).



STEP 2

Remove the main "Air-Valve Assembly" from the pump.

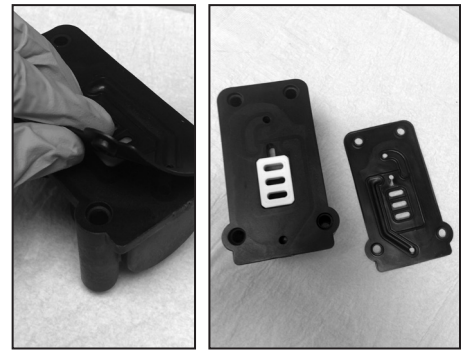

STEP 3

Remove the "Air-Valve Gasket" from the main "Air-Valve Assembly".

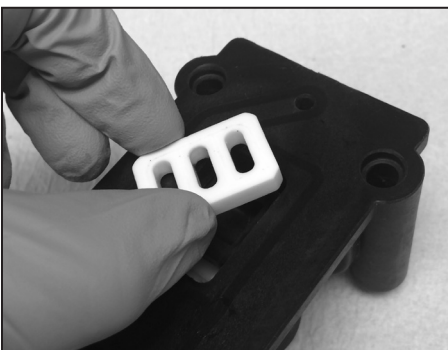

STEP 4

Remove the "Shuttle Plate" from the main "Air-Valve Assembly".

Note: The smooth shiny side of the shuttle plate should be toward the shuttle car.



STEP 5

Remove the "Shuttle" from the main "Air-Valve Assembly".



STEP 6

Using the pair of pliers, remove the "Air Valve End Plug" from the main "Air-Valve Assembly". Ensure the "O-Ring" is installed when reassembling.

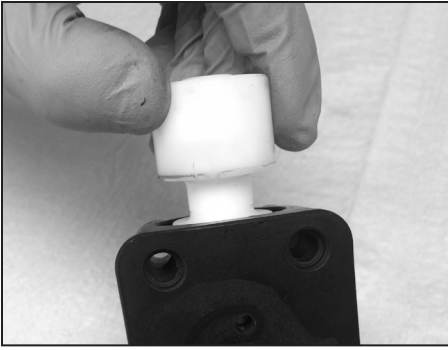

STEP 7

Remove the "Air Valve Spool" from the main "Air-Valve Assembly".

Note: The longer piston is on the plug side.



STEP 8

Using the pick, remove the "Lip Seal (Air Valve)" from the main "Air-Valve Assembly".



STEP 9

Using the pick, remove the second "Lip Seal (Air Valve)" from the main "Air-Valve Assembly".

AIR VALVE ASSEMBLY

To assemble the air valve, reverse the order of disassembly. During assembly, ensure that the open side of the lip-seals are both facing each other inward. Install the shuttle plate with the smooth/shiny side toward the shuttle car. Lubrication of the air valve assembly, with a non-synthetic lubricant, is recommended. Magna-Lube or Magna-Plate are recommended for assembly lubrication (see detailed parts list for ordering information).

Note that if the lip-seals are installed incorrectly, they will be unable to rotate. Insert the spool, larger chamfer side first, the spool's longer piston is to be on the plug side, ensure O-Ring is installed, and then the air-valve end plug into position.

REPAIR AND ASSEMBLY

PILOT VALVE REMOVAL

TOOLS NEEDED

- 1) One Screwdriver, Phillips #2
- 2) Two Wrenches, $\frac{7}{16}$ Inch

⚠️ WARNING Prior to servicing the pump, ensure that the air and fluid lines are closed and disconnected. While wearing personal protective equipment, flush, drain and process liquid from the pump in a safe manner.

⚠️ WARNING Maintenance must not be performed when a hazardous atmosphere is present.

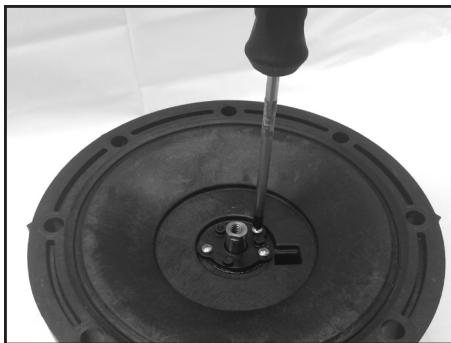

STEP 1

Using the screwdriver, remove three "Phillips Pan-Head Screws" in order to remove the "Retaining Plate". Repeat for other side of the pump.



STEP 2

Remove the "Diaphragm Rod" and the "Pilot Sleeve Assembly" from the "Intermediate".



STEP 3

Remove both "Lip Seals (Diaphragm Rod)" and both "End Spacers (Pilot Sleeve)" from the "Pilot Sleeve Assembly". Remove both "O-Rings (End Spacer)" from both "End Spacers (Pilot Sleeve)".



STEP 4

Remove three "Inner Spacers (Pilot Sleeve)" and four "O-Rings (Pilot Sleeve)" from the "Pilot Sleeve Assembly".



STEP 5

Using two $\frac{7}{16}$ inch wrenches, disassemble the "Diaphragm Rod Assembly" into its two parts.

Note: They are installed with thread locker.



STEP 6

Remove the "Pilot Sleeve" from the disassembled "Diaphragm Rod Assembly".

PILOT VALVE ASSEMBLY

To assemble the pilot valve, reverse the order of disassembly. Should process fluid have contact with the pilot valve O-Rings, they should be replaced as swelling may occur and cause irregular operation. During assembly, ensure that the open side of the lip-seals are facing outward. Lubrication of the pilot sleeve assembly, with a non-synthetic lubricant, is recommended in order to facilitate re-assembly into the intermediate. Magna-Lube or Magna-Plate are recommended for assembly lubrication (see detailed parts list for ordering information).

TORQUE SPECIFICATION CHART

RECOMMENDED TORQUE SPECIFICATIONS

3/4" Pumps	
Manifold Bolts	85-90 in-lbs (9.6-10.2 N-m)
Chamber Bolts	50 in-lbs (5.6 N-m)
Air Valve Bolts	40 in-lbs (4.52 N-m)
Diaphragm Plates	70 in-lbs (7.9 N-m)

Note: Always torque the chamber bolts prior to the manifold bolts. When reassembling, loosely tighten all external fasteners adjusting and aligning gradually, in an alternating fashion, tighten to torque requirements listed above.

Note: When using pumps built with PTFE O-Rings, always replace with new PTFE O-Rings, since the original O-Rings may not reseal the pump.

EXPLODED VIEW & PARTS LIST

A075-*P*-*****-******** BOLTED PLASTIC

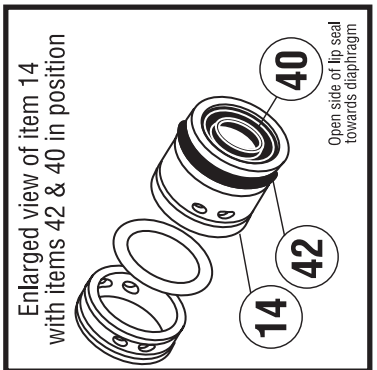
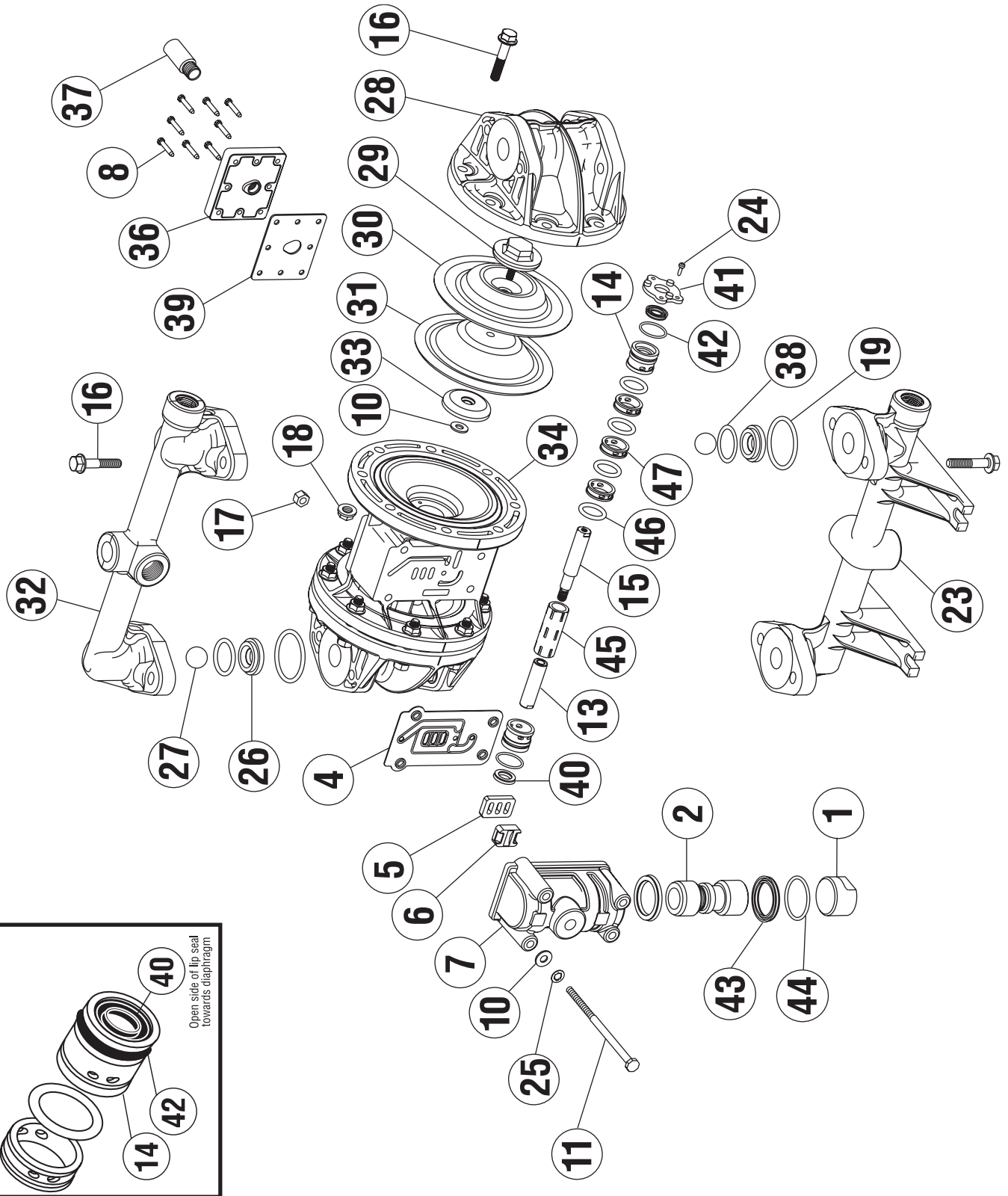

PARTS LIST - BOLTED PLASTIC

A075-*P*-****-****

ITEM	DESCRIPTION	QTY	PUMP MODEL	PART NO.	MATERIAL
1	AIR VALVE END PLUG	1	ALL MODELS	11703-60	Polypropylene
2	AIR VALVE SPOOL	1	ALL MODELS	10480-31	Acetal
4	AIR VALVE GASKET	1	ALL MODELS	12116-19	Nitrile
5	SHUTTLE PLATE	1	ALL MODELS	10416-77	Ceramic
6	SHUTTLE	1	ALL MODELS	10415-00	Special
7	AIR VALVE BODY	1	ALL MODELS	11614-60	Polypropylene
8	SLT WSHD SCREW (#8 X 1")	8	ALL MODELS (NON-PTFE COATED)	12525-26	Stainless Steel
10	FLAT WASHER (1/4")	6	ALL MODELS (NON-PTFE COATED)	12300-26	Stainless Steel
11	CAP SCREW (1/4" X 4-1/2")	4	ALL MODELS (NON-PTFE COATED)	12513-26	Stainless Steel
13	DIAPHRAGM ROD (Short)	1	ALL MODELS	*SEE NOTE	Stainless Steel
14	END SPACER (Pilot Sleeve)	2	ALL MODELS	10204-40	Polypropylene
15	DIAPHRAGM ROD (Long)	1	ALL MODELS	*SEE NOTE	Stainless Steel
16	FLNG BOLT (5/16" X 1-5/8")	24	ALL MODELS (NON-PTFE COATED)	12539-26	Stainless Steel
17	HEX NUT (1/4" - 20)	4	ALL MODELS (NON-PTFE COATED)	12600-26	Stainless Steel
18	FLNG HEX NUT (5/16" - 18)	24	ALL MODELS (NON-PTFE COATED)	12608-26	Stainless Steel
19	O-RING (Manifolds)	4	A075-*P*-****N-**** A075-*P*-****V-**** A075-*P*-****E-**** A075-*P*-****T-****	11936-11 + 11936-13 + 11936-15 + 11936-17 +	Nitrile FKM EPDM PTFE
23	SUCTION MANIFOLD		A075-NPP-****-**** (SIDE PORTED) A075-BPP-****-**** (SIDE PORTED) A075-NPK-****-**** (SIDE PORTED) A075-BPK-****-**** (SIDE PORTED)	10534-40 10534-40-BSP 10534-56 10534-56-BSP	Polypropylene Polypropylene PVDF PVDF
24	SELF TAP SCREW (#6 X 1/2")	6	ALL MODELS	12510-26	Stainless Steel
25	LOCK WASHER (1/4")	4	ALL MODELS (NON-PTFE COATED)	12350-26	Stainless Steel
26	VALVE SEAT	4	A075-*P*-*3**-**** A075-*P*-*P**-**** A075-*P*-*K**-****	10906-26 + 10906-40 + 10906-56 +	Stainless Steel Polypropylene PVDF
27	BALL	4	A075-*P*-*V**-**** A075-*P*-*G**-**** A075-*P*-*S**-**** A075-*P*-*3**-**** A075-*P*-*T**-****	11000-13 + 11000-19 + 11000-23 + 11000-26 + 11000-45 +	FKM Bunalast™ Santoprene® Stainless Steel PTFE
28	OUTER CHAMBER	2	A075-*PP-****-**** A075-*PY-****-**** A075-*PK-****-****	10720-40 10720-46 10720-56	Polypropylene Conductive Nylon PVDF
29	OUTER DIAPHRAGM PLATE	2	A075-*PP-****-**** A075-*PK-****-****	11200-40 11200-56	Polypropylene PVDF
30	OVERLAY (PTFE ONLY)	2	A075-*P*-*T***-****	11400-59 +	PTFE
31	DIAPHRAGM	2	A075-*P*-*V***-**** A075-*P*-*G***-**** A075-*P*-*S***-**** A075-*P*-*T***-****	10600-13 + 10600-19 + 10600-23 + 10600-23 +	FKM Bunalast™ Santoprene® Santoprene®

PARTS LIST - BOLTED PLASTIC

A075-*P*-*-*-***

ITEM	DESCRIPTION	QTY	PUMP MODEL	PART NO.	MATERIAL
32	DISCHARGE MANIFOLD	1	A075-*PP-*-*-***	10535-AF-40	Polypropylene
			A075-*PP-*-*-***	10535-AF-40-BSP	Polypropylene
			A075-*PK-*-*-***	10535-AF-56	PVDF
			A075-*PK-*-*-***	10535-AF-56-BSP	PVDF
33	INNER DIAPHRAGM PLATE	2	A075-*PP-*-*-***	11100-40	Polypropylene
			A075-*PK-*-*-***	11100-56	PVDF
34	INTERMEDIATE	1	ALL MODELS	11521-60	Polypropylene
36	MUFFLER PLATE	1	ALL MODELS	13111-60	Polypropylene
37	MUFFLER	1	ALL MODELS	13008-00	Polypropylene
38	O-RING (Valve Seat)	4	A075-*P*-*-*-N-*-*-***	11937-11 †	Nitrile
			A075-*P*-*-*-V-*-*-***	11937-13 †	FKM
			A075-*P*-*-*-E-*-*-***	11937-15 †	EPDM
			A075-*P*-*-*-T-*-*-***	11937-17 †	PTFE
39	GASKET (Muffler Plate)	1	ALL MODELS	12117-19	Nitrile
40	LIP SEAL (Diaphragm Rod)	2	ALL MODELS	12000-76	Nitrile
41	RETAINING PLATE	2	ALL MODELS	12708-54	Nylon
42	O-RING (End Spacer)	2	ALL MODELS	11923-11	Nitrile
43	AIR VALVE LIP SEAL	2	ALL MODELS	12003-76	Nitrile
44	O-RING (Valve End Plug)	1	ALL MODELS	11913-11	Nitrile
45	PILOT SLEEVE	1	ALL MODELS	10105-31	Acetal
46	O-RING (Pilot Sleeve)	4	ALL MODELS	11920-16	Urethane
47	INNER SPACER (Pilot Sleeve)	3	ALL MODELS	10203-40	Polypropylene

* Any Character

* NOTE: DIAPHRAGM ROD CAN ONLY BE PURCHASED AS AN ASSEMBLY.

DIAPHRAGM ROD ASSEMBLY Items 13 & 15	1	ALL MODELS	33000-00	Stainless Steel
---	---	------------	----------	-----------------

OPTIONAL ASSEMBLIES AVAILABLE

MAIN AIR VALVE ASSEMBLY Items 1, 2, 4, 5, 6, 7, 43, 44	1	ALL MODELS	AMK-075-P	Various
PILOT VALVE ASSEMBLY Items 14, 40, 42, 45, 46, 47	1	ALL MODELS	APK-075-P	Various
PILOT SLEEVE ELASTOMER KIT Items 14, 40, 42, 46, 47	1	ALL MODELS	PEK-32000	Various
† WET END ASSEMBLY Items 19, 26, 27, 30, 31, 38	1	ALL MODELS	AWE-075-*-*-P	Various

ELASTOMERS & REPAIR KITS

WETTED ELASTOMERS

BUNA-N (NITRILE)

is a general purpose elastomer used with water and many oils. Temperature range 10°F to 180°F (-12°C to 82°C).

BUNALAST™

is an injection molded thermoplastic material with characteristics similar to Santoprene®. Has excellent abrasion resistance. Temperature range -40°F to 266°F (-40°C to 130°C).

EPDM

is a general purpose elastomer with good resistance to many acids and bases. Temperature range -40°F to 280°F (-40°C to 138°C).

SANTOPRENE®

is an injection molded material with characteristics similar to EPDM. Has excellent abrasion resistance. Temperature range -40°F to 225°F (-40°C to 107°C).

FKM

is an elastomer with good corrosion resistance to a wide variety of chemicals. Temperature range -40°F to 350°F (-40°C to 177°C).

PTFE (POLYTETRAFLUOROETHYLENE)

is a thermoplastic polymer that is inert to most chemicals. Temperature range 40°F to 220°F (4°C to 104°C).

Most of the above elastomers are available in FDA approved formulations.

Geolast® is a registered trademark of ExxonMobil Chemical Co.

Santoprene® is a registered trademark of ExxonMobil Chemical Co.

Hytrel® is a registered trademark of DuPont Performance Elastomers L.L.C.

Magnalube® is a registered trademark of Carleton-Stuart Corp.

WARRANTY AND REGISTRATION

WARRANTY. All All-Flo products shall be covered by the standard All-Flo Limited Warranty in effect at the time of shipment. This warranty (which may be modified by All-Flo at any time) provides:

MATERIALS SOLD ARE WARRANTED TO THE ORIGINAL USER AGAINST DEFECTS IN WORKMANSHIP OR MATERIALS UNDER NORMAL USE (RENTAL USE EXCLUDED) FOR FIVE YEARS AFTER PURCHASE DATE. ANY PUMP WHICH IS DETERMINED TO BE DEFECTIVE IN MATERIAL AND WORKMANSHIP AND RETURNED TO ALL-FLO, SHIPPING COSTS PREPAID, WILL BE REPAIRED OR REPLACED AT ALL-FLO'S OPTION. CUSTOMER SHALL NOTIFY ALL-FLO IN WRITING WITHIN 30 DAYS OF ANY CLAIMED DEFECTS. NO MATERIALS CAN BE RETURNED WITHOUT THE PRIOR CONSENT OF ALL-FLO, AND IF APPROVED SHALL BE RETURNED TO ALL-FLO FREIGHT PREPAID. ALL-FLO'S LIABILITY FOR ANY BREACH OF THIS WARRANTY SHALL BE LIMITED TO EITHER REPLACEMENT OF THE MATERIALS OR, AT ALL-FLO'S SOLE OPTION, THE REFUND OF THE PURCHASE PRICE. ALL-FLO SHALL NOT BE HELD LIABLE FOR ANY INCIDENTAL OR CONSEQUENTIAL DAMAGES CAUSED BY BREACH OF THIS WARRANTY. THIS EXCLUSION APPLIES WHETHER SUCH DAMAGES WERE SOUGHT BASED ON BREACH OF WARRANTY, BREACH OF CONTRACT, NEGLIGENCE, STRICT LIABILITY IN TORT, OR ANY OTHER LEGAL THEORY. FURTHER, ALL-FLO SHALL NOT BE LIABLE FOR LOSSES, DELAYS, LABOR COSTS, OR ANY OTHER COST OR EXPENSE DIRECTLY OR INDIRECTLY ARISING FROM THE USE OF MATERIALS. ALL-FLO'S LIABILITY IS EXPRESSLY LIMITED TO THE REPLACEMENT OR REPAIR OF DEFECTIVE GOODS, OR THE TOTAL VALUE OF SUCH GOODS. THIS WARRANTY IS IN LIEU OF ALL OTHER WARRANTIES, WHETHER EXPRESS, IMPLIED, OR ORAL INCLUDING THE IMPLIED WARRANTY OF MERCHANTABILITY, ANY IMPLIED WARRANTY OF FITNESS FOR A PARTICULAR PURPOSE, AND ANY IMPLIED WARRANTIES OTHERWISE ARISING FROM A COURSE OF DEALING OR TRADE. All-Flo will not, in ANY event, be liable for any loss of profit, interruption of business or any other special, consequential or incidental damages suffered or sustained by Customer. All-Flo's total maximum liability to the customer in respect of sale of materials or services rendered by All-Flo is limited to the total monies received by All-Flo from the customer for the particular materials described in Customer's order.

All-Flo does not warrant any part or component that it does not manufacture, but will assign to the original end-user purchaser of any warranty received by it from the manufacturer, to extent such pass through is permitted by the manufacturer.



REGISTRATION FORM

Pump Model _____ Pump Serial Number _____

Company Name _____

Name _____ Email _____

Phone # _____ City _____ State _____ Zip _____

Qty of Pumps _____ Fluid Pumping _____

How did you hear about us? Existing All-Flo user,
Web, Distributor, Magazine...

MAIL TO: All-Flo | Attn: Product Registration
22069 Van Buren Street, Grand Terrace, CA 92313-5651



Scan QR code and
complete form
on mobile phone
or visit

www.all-flo.com/registration-form.html



PSG

22069 Van Buren Street

Grand Terrace, CA 92313-5651 USA

P: +1 (440) 354-1700 F: +1 (440) 354-9466

all-flo.com

All-Flo is committed to the pursuit of designing and manufacturing the highest quality product available to industry. Since the beginning in 1986, All-Flo engineers have used their extensive knowledge of today's engineered materials, advanced air system logic and manufacturing techniques to develop the superior group of lube-free, air-operated diaphragm pumps found in this catalog. Every pump is performance engineered and quality built to provide trouble-free service under the toughest conditions.



Where Innovation Flows